

ML-1860 Series  
ML-1865 Series

# Mono Laser Printer User's Guide

imagine the possibilities

Thank you for purchasing a Samsung product.



# copyright

---

© 2010 Samsung Electronics Co., Ltd. All rights reserved.

This user's guide is provided for information purposes only. All information included herein is subject to change without notice.

Samsung Electronics is not responsible for any direct or indirect damages, arising from or related to use of this user's guide.

- Samsung and Samsung logo are trademarks of Samsung Electronics Co., Ltd.
- PCL and PCL 6 are trademarks of Hewlett-Packard Company.
- Microsoft, Internet Explorer, Windows, Windows Vista, Windows 7 and Windows 2008 Server R2 either registered trademarks or trademarks of Microsoft Corporation.
- PostScript 3 is a trademark of Adobe System, Inc.
- UFST® and MicroType™ are registered trademarks of Monotype Imaging Inc.
- TrueType, Mac and Mac OS are trademarks of Apple Inc., registered in the U.S and other countries.
- LaserWriter is a trademark of Apple Inc.
- All other brand or product names are trademarks of their respective companies or organizations.

Refer to the 'LICENSE.txt' file in the provided CD-ROM for the open source license information.

REV. 1.04

# safety information









These warnings and precautions are included to prevent injury to you and others, and to prevent any potential damage to your machine. Be sure to read and understand all of these instructions before using the machine.

Use common sense for operating any electrical appliance and whenever using your machine. Also, follow all warnings and instructions marked on the machine and in the accompanying literature. After reading this section, keep it in a safe place for future reference.

## Important safety symbols

This section explains the meanings of all icons and signs in the user's guide. These safety symbols are in order, according to the degree of danger.

### Explanation of all icons and signs used in the user's guide:

	<b>Warning</b>	Hazards or unsafe practices that may result in severe personal injury or death.
	<b>Caution</b>	Hazards or unsafe practices that may result in minor personal injury or property damage.
		Do not attempt.
		Do not disassemble.
		Do not touch.
		Unplug the power cord from the wall socket.
		Make sure the machine is grounded to prevent electric shock.
		Call the service center for help.
		Follow directions explicitly.

## Operating environment

### Warning



Do not use if the power cord is damaged or if the electrical outlet is not grounded.

► This could result in electric shock or fire.



Do not bend, or place heavy objects on the power cord.

► Stepping on or allowing the power cord to be crushed by a heavy object could result in electric shock or fire.



Do not place anything on top of the machine (water, small metal or heavy objects, candles, lit cigarettes, etc.).

► This could result in electric shock or fire.



Do not remove the plug by pulling on the cord; do not handle the plug with wet hands.

► This could result in electric shock or fire.

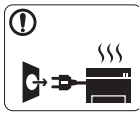

If the machine gets overheated, it releases smoke, makes strange noises, or generates an odd odor, immediately turn off the power switch and unplug the machine.

► This could result in electric shock or fire.

### Caution

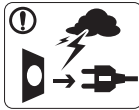

During an electrical storm or for a period of non-operation, remove the power plug from the electrical outlet.

► This could result in electric shock or fire.



Be careful, the paper output area is hot.

► Burns could occur.



If the machine has been dropped, or if the cabinet appears damaged, unplug the machine from all interface connections and request assistance from qualified service personnel.

► Otherwise, this could result in electric shock or fire.



If the machine exhibits a sudden and distinct change in performance, unplug the machine from all interface connections and request assistance from qualified service personnel.

► Otherwise, this could result in electric shock or fire.



If the plug does not easily enter the electrical outlet, do not attempt to force it in.

► Call an electrician to change the electrical outlet, or this could result in electric shock.



Do not allow pets to chew on the AC power, telephone or PC interface cords.

► This could result in electric shock or fire and/or injury to your pet.



If the machine does not operate properly after these instructions have been followed, unplug the machine from all interface connections and request assistance from qualified service personnel.

► Otherwise, this could result in electric shock or fire.

## Operating method

### Caution



Do not forcefully pull the paper out during printing.

► It can cause damage to the machine.



Be careful not to put your hand between the machine and paper tray.

► You may get injured.



Do not block or push objects into the ventilation opening.

► This could result in elevated component temperatures which can cause damage or fire.



Be care when replacing paper or removing jammed paper.

► New paper has sharp edges and can cause painful cuts.



When printing large quantities, the bottom part of the paper output area may get hot. Do not allow children to touch.

► Burns can occur.



When removing jammed paper, do not use tweezers or sharp metal objects.

► It can damage the machine.



Do not allow too many papers to stack up in the paper output tray.

► It can damage the machine.



This machine's power interception device is the power cord.

► To switch off the power supply, remove the power cord from the electrical outlet.



## Installation / Moving

### Warning



Do not place the machine in an area with dust, humidity or water leaks.  
▶ This could result in electric shock or fire.



### Caution



Before moving the machine, turn the power off and disconnect all cords.  
Then lift the machine:

- If the machine weighs under 20 kg (44.09lb), lift with 1 person.
- If the machine weighs 20 kg (44.09lb) - 40kg (88.18lb), lift with 2 people.
- If the machine weighs more than 40 kg (88.18lb), lift with 4 or more people.

▶ The machine could fall, causing injury or machine damage.

-  Do not place the machine on an unstable surface.  
▶ The machine could fall, causing injury or machine damage.
-  The machine should be connected to the power level which is specified on the label.  
▶ If you are unsure and want to check the power level you are using, contact the electrical utility company.
-  Use only No.26 AWG<sup>a</sup> or larger, telephone line cord, if necessary.  
▶ Otherwise, it can cause damage to the machine.

a. AWG: American Wire Gauge

-  Do not put a cover over the machine or place it in an airtight location, such as a closet.  
▶ If the machine is not well-ventilated, this could result in fire.

-  Make sure you plug the power cord into a grounded electrical outlet.  
▶ Otherwise, this could result in electric shock or fire.

-  Do not overload wall outlets and extension cords.  
▶ This can diminish performance, and could result in electric shock or fire.

-  Use the power cord supplied with your machine for safe operation. If you are using a cord which is longer than 2 meters (6 feet) with a 140V machine, then the gauge should be 16 AWG or larger.  
▶ Otherwise, it can cause damage to the machine, and could result in electric shock or fire.

## Maintenance / Checking

### Caution



Unplug this product from the wall outlet before cleaning the inside of the machine. **Do not** clean the machine with benzene, paint thinner or alcohol; do not spray water directly into the machine.

▶ This could result in electric shock or fire.



Keep cleaning supplies away from children.  
▶ Children could get hurt.



When you are working inside the machine replacing supplies or cleaning the inside, do not operate the machine.

▶ You could get injured.

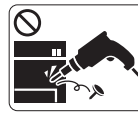

Do not disassemble, repair or rebuild the machine by yourself.

▶ It can damage the machine. Call a certified technician when the machine needs repair.

ⓘ Keep the power cable and the contact surface of the plug clean from dust or water.

▶ Otherwise, this could result in electric shock or fire.

ⓘ To clean and operate the machine, strictly follow the user's guide provided with the machine.

▶ Otherwise, you could damage the machine.

⊘ Do not remove any covers or guards that are fastened with screws.

▶ The machine should only be repaired by a Samsung service technician.

## Supply usage

---

### Caution



Do not disassemble the toner cartridge.

▶ Toner dust can be dangerous if inhaled or ingested.



When storing supplies such as toner cartridges, keep them away from children.

▶ Toner dust can be dangerous if inhaled or ingested.



Do not burn any of the supplies such as toner cartridge or fuser unit.

▶ This could cause an explosion or uncontrollable fire.

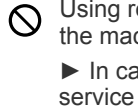

⊘ Using recycled supplies, such as toner, can cause damage to the machine.

▶ In case of damage due to the use of recycled supplies, a service fee will be charged.

ⓘ When changing the toner cartridge or removing jammed paper, be careful not to let toner dust touch your body or clothes.

▶ Toner dust can be dangerous if inhaled or ingested.

ⓘ When toner gets on your clothing, do not use hot water to wash it.

▶ Hot water sets toner into fabric. Use cold water.

# regulatory information

This machine is designed for a normal work environment and certified with several regulatory statements.

## Laser Safety Statement

The printer is certified in the U.S. to conform to the requirements of DHHS 21 CFR, chapter 1 Subchapter J for Class I(1) laser products, and elsewhere is certified as a Class I laser product conforming to the requirements of IEC 60825-1.

Class I laser products are not considered to be hazardous. The laser system and printer are designed so there is never any human access to laser radiation above a Class I level during normal operation, user maintenance or prescribed service condition.

- **Wavelength:** 800 nm
- **Beam divergence**
  - **Paraller:** 11 degrees
  - **Perpendicular:** 35 degrees
- **Maximum power of energy output:** 12 mW

### WARNING

Never operate or service the printer with the protective cover removed from Laser/Scanner assembly. The reflected beam, although invisible, can damage your eyes.

When using this product, these basic safety precautions should always be followed to reduce risk of fire, electric shock, and injury to persons:



## Ozone Safety



During normal operation, this machine produces ozone. The ozone produced does not present a hazard to the operator. However, it is advisable that the machine be operated in a well ventilated area.

If you need additional information about ozone, contact your local Samsung dealer.

## Power Save

---



This printer contains advanced energy conservation technology that reduces power consumption when it is not in active use. When the printer does not receive data for an extended period of time, power consumption is automatically lowered. ENERGY STAR and the ENERGY STAR mark are registered U.S. marks. For more information on the ENERGY STAR program see <http://www.energystar.gov>.

## Recycling

---



Recycle or dispose of the packaging material for this product in an environmentally responsible manner.

## China only

---

### 回收和再循环

为了保护环境，我公司已经为废弃的产品建立了回收和再循环系统。我们会为您无偿提供回收同类废旧产品的服务。当您要废弃您正在使用的产品时，请您及时与工厂取得联系，我们会及时为您提供服务。

## Correct Disposal of This Product (Waste Electrical & Electronic Equipment)

---



### **(Applicable in the European Union and other European countries with separate collection systems)**

This marking shown on the product, accessories or literature indicates that the product and its electronic accessories (e.g. charger, headset, USB cable) should not be disposed of with other household wastes at the end of its working life. To prevent possible harm to the environment or human health from uncontrolled waste disposal, separate this from other types of wastes and recycle it responsibly to promote the sustainable reuse of material resources.

Household users should contact either the retailer where they purchased this product, or their local government office, for details of where and how they can take this item for environmentally safe recycling.

Business users should contact their supplier and check the terms and conditions of the purchase contract. This product should not be mixed with other commercial wastes for disposal.

## Radio Frequency Emissions

---

### **FCC Information to the User**

This device complies with Part 15 of the FCC Rules. Operation is subject to the following two conditions:

- This device may not cause harmful interference, and
- This device must accept any interference received, including interference that may cause undesired operation.

This equipment has been tested and found to comply with the limits for a Class B digital device, pursuant to Part 15 of the FCC Rules. These limits are designed to provide reasonable protection against harmful interference in a residential installation. This equipment generates, uses and can radiate radio frequency energy and, if not installed and used in accordance with the instructions, may cause harmful interference to radio communications. However, there is no guarantee that interference will not occur in a particular installation. If this equipment does cause harmful interference to radio or television reception, which can be determined by turning the equipment off and on, the user is encouraged to try to correct the interference by one or more of the following measures:

- Reorient or relocate the receiving antenna.
- Increase the separation between the equipment and receiver.
- Connect the equipment into an outlet on a circuit different from that to which the receiver is connected.
- Consult the dealer or experienced radio TV technician for help.

 Change or modifications not expressly approved by the manufacturer responsible for compliance could void the user's authority to operate the equipment.

### Canadian Radio Interference Regulations

This digital apparatus does not exceed the Class B limits for radio noise emissions from digital apparatus as set out in the interference-causing equipment standard entitled "Digital Apparatus", ICES-003 of the Industry and Science Canada.

Cet appareil numérique respecte les limites de bruits radioélectriques applicables aux appareils numériques de Classe B prescrites dans la norme sur le matériel brouilleur: "Appareils Numériques", ICES-003 édictée par l'Industrie et Sciences Canada.

## Russia only

---



## Yalnızca Türkiye

---

- **RoHS**  
EEE Yönetmeliğine Uygundur.  
This EEE is compliant with RoHS.
- Bu ürünün ortalama yaşam süresi 7 yıl, garanti süresi 2 yıldır.

## Germany only

---

Das Gerät ist nicht für die Benutzung am Bildschirmarbeitsplatz gemäß BildschirmV vorgesehen.

## Replacing the Fitted Plug (for UK Only)

---

### Important

The mains lead for this machine is fitted with a standard (BS 1363) 13 amp plug and has a 13 amp fuse. When you change or examine the fuse, you must re-fit the correct 13 amp fuse. You then need to replace the fuse cover. If you have lost the fuse cover, do not use the plug until you have another fuse cover.

Contact the people from you purchased the machine.

The 13 amp plug is the most widely used type in the UK and should be suitable. However, some buildings (mainly old ones) do not have normal 13 amp plug sockets. You need to buy a suitable plug adaptor. Do not remove the moulded plug.

 If you cut off the moulded plug, get rid of it straight away.

You cannot rewire the plug and you may receive an electric shock if you plug it into a socket.

## Important warning:



You must earth this machine.

The wires in the mains lead have the following color code:

- **Green and Yellow:** Earth
- **Blue:** Neutral
- **Brown:** Live

If the wires in the mains lead do not match the colors marked in your plug, do the following:

You must connect the green and yellow wire to the pin marked by the letter “E” or by the safety ‘Earth symbol’ or colored green and yellow or green.

You must connect the blue wire to the pin which is marked with the letter “N” or colored black.

You must connect the brown wire to the pin which is marked with the letter “L” or colored red.

You must have a 13 amp fuse in the plug, adaptor, or at the distribution board.

## Declaration of Conformity (European Countries)

---

### Approvals and Certifications



The CE marking applied to this product symbolizes Samsung Electronics Co., Ltd. Declaration of Conformity with the following applicable 93/68/EEC Directives of the European Union as of the dates indicated:

Hereby, Samsung Electronics declare that this product is in compliance with the essential requirements and other relevant provisions of:

**ML-1860 Series/ML-1865 Series:** Low Voltage Directive (2006/95/EC) and EMC Directive (2004/108/EC).

The declaration of conformity may be consulted at [www.samsung.com/printer](http://www.samsung.com/printer), go to Support > Download center and enter your printer (MFP) name to browse the EuDoC.

**January 1, 1995:** Council Directive 2006/95/EC Approximation of the laws of the member states related to low voltage equipment.

**January 1, 1996:** Council Directive 2004/108/EC (92/31/EEC), approximation of the laws of the Member States related to electromagnetic compatibility.

**March 9, 1999:** Council Directive 1999/5/EC on radio equipment and telecommunications terminal equipment and the mutual recognition of their conformity. A full declaration, defining the relevant Directives and referenced standards can be obtained from your Samsung Electronics Co., Ltd. representative.

### EC Certification

Certification to 1999/5/EC Radio Equipment & Telecommunications Terminal Equipment Directive (FAX)

This Samsung product has been self-certified by Samsung for pan-European single terminal connection to the analogue public switched telephone network (PSTN) in accordance with Directive 1999/5/EC. The product has been designed to work with the national PSTNs and compatible PBXs of the European countries:

In the event of problems, you should contact the Euro QA Lab of Samsung Electronics Co., Ltd. in the first instance.

The product has been tested against TBR21. To assist in the use and application of terminal equipment which complies with this standard, the European Telecommunication Standards Institute (ETSI) has issued an advisory document (EG 201 121) which contains notes and additional requirements to ensure network compatibility of TBR21 terminals. The product has been designed against, and is fully compliant with, all of the relevant advisory notes contained in this document.



## 产品中有毒有害物质或元素的名称及含量

部件名称	有毒有害物质或元素					
	铅 (Pb)	汞 (Hg)	镉 (Cd)	六价铬 (Cr <sup>6+</sup> )	多溴联苯 (PBB)	多溴联苯醚 (PBDE)
塑料	○	○	○	○	○	○
金属 ( 机箱 )	X	○	○	○	○	○
印刷电路部件 (PCA)	X	○	○	○	○	○
电缆 / 连接器	X	○	○	○	○	○
电源设备	X	○	○	○	○	○
电源线	X	○	○	○	○	○
机械部件	X	○	○	○	○	○
卡盒部件	X	○	○	○	○	○
定影部件	X	○	○	○	○	○
扫描仪部件 - CCD ( 如果有 )	X	X	○	○	○	○
扫描仪部件 - 其它 ( 如果有 )	X	○	○	○	○	○
印刷电路板部件 (PBA)	X	○	○	○	○	○
墨粉	○	○	○	○	○	○
滚筒	○	○	○	○	○	○

○：表示该有毒有害物质在该部件所有均质材料中的含量均在 SJ/T 11363-2006 标准规定的限量要求以下。

×：表示该有毒有害物质至少在该部件的某一均质材料中的含量超出 SJ/T 11363-2006 标准规定的限量要求。

以上表为目前本产品含有有毒有害物质的信息。本信息由本公司的配套厂家提供，经本公司审核后而做成，本产品的部分部件含有有毒有害物质，这些部件是在现有科学技术水平下暂时无可替代物质，但三星电子将会一直为满足 SJ/T 11363-2006 标准而做不懈的努力。



# about this user's guide

---

This user's guide provides information about basic understanding of the machine as well as detailed explanation on each step during actual usage. It is a valuable resource for both novice and professional users for the proper installation and use of the machine.

-  Read the safety information before using the machine.
- If you have a problem using the machine, refer to the troubleshooting chapter. (See "Troubleshooting" on page 49.)
- Terms used in this user's guide are explained in the glossary chapter. (See "Glossary" on page 65.)
- Illustrations in this user's guide may differ from your machine depending on its options or models.
- The procedures in this user's guide are mainly based on Windows XP.



## Convention

---

Some terms in this guide are used interchangeably, as below:

- Document is synonymous with original.
- Paper is synonymous with media, or print media.
- Machine refers to printer or MFP.

The following table offers the conventions of this guide:

Convention	Description	Example
<b>Bold</b>	For texts on the display or button names on the machine.	<b>Cancel</b>
<b>Note</b>	Provides additional information or details for the machine function and feature.	 The date format may differ from country to country.
<b>Caution</b>	Contains information you can use to protect the machine from possible mechanical damage or malfunction.	 Do not touch the surface of the drum located in the toner cartridge or imaging unit.
<b>Footnote</b>	Provides additional information on certain words or a phrases.	a. pages per minute
<b>(“Cross-reference”)</b>	Refers you to additional detailed information.	(See "Finding more information" on page 14.)

## Finding more information

You can find information about setting up and using your machine in the following resources, either as a print-out or on screen.

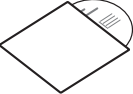
Material name	Description
<b>Quick Install Guide</b> 	This guide provides information on setting up your machine. This guide is provided in the box with the printer.
<b>User's Guide</b> 	This guide provides you with step-by-step instructions for using your machine's full features, maintaining your machine, troubleshooting, and replacing supplies.
<b>Machine Driver Help</b>	This help provides you with information about the printer driver and instructions for setting up the options for printing. (See "Using help" on page 35.)
<b>Samsung website</b>	If you have Internet access, you can get help, support, machine drivers, manuals, and order information from the Samsung website, <a href="http://www.samsung.com/printer">www.samsung.com/printer</a> .
<b>Downloadable software</b>	You can download useful software programs from the Samsung website. <ul style="list-style-type: none"><li>• <b>Samsung AnyWeb Print:</b> helps personal users to screen-capture the website screen in Windows Internet Explorer, Windows Firefox and Macintosh Safari easily. (<a href="http://solution.samsungprinter.com/personal/anywebprint">http://solution.samsungprinter.com/personal/anywebprint</a>)</li></ul>

# features of your new product

---

Your new machine is equipped with a number of special features that improve the quality of the documents you print.

## Special Features

---

### Print with excellent quality and speed



- You can print with a resolution of up to 1,200 x 1200 dpi effective output.
- Your machine prints A4-sized paper at up to 18 ppm and letter-sized paper at up to 19 ppm.

### Handle many different types of printable material

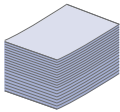

- The 150-sheet tray supports plain paper in various sizes, letterhead, envelopes, labels, custom-sized media, postcards, and heavy paper.

### Create professional documents

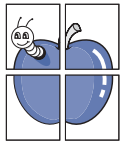

- Print Watermarks. You can customize your documents with words, such as "Confidential". (See "Using watermarks" on page 36.)
- Print Posters. The text and pictures of each page of your document are magnified and printed across the sheet of paper and can then be taped together to form a poster. (See "Printing posters" on page 35.)
- You can use preprinted forms and letterhead with plain paper. (See "Using overlays" on page 37.)

### Save time and money



- To save paper, you can print multiple pages on one single sheet of paper. (See "Printing multiple pages on one sheet of paper" on page 35.)
- This machine automatically conserves electricity by substantially reducing power consumption when not in use.
- To save paper, you can print on both sides of the paper (Manual). (See "Printing on both sides of the paper (Manual)" on page 35.)

### Print in various environments



- You can print with Windows as well as Linux and Macintosh OS systems.
- Your machine is equipped with a USB interface.

## Features by Models

---

The machine is designed to support all of your document needs from printing to more advanced networking solutions for your business. Features by models include:

FEATURES	ML-1860 Series	ML-1865 Series
High Speed USB 2.0	•	•
Duplex (2-sided) printing (Manual)	•	•

(•: Included)



# introduction

---

This chapter gives you an overview of your machine:

**This chapter includes:**

- Machine overview
- Control panel overview
- Understanding the status LED

## Machine overview

---

### Front view

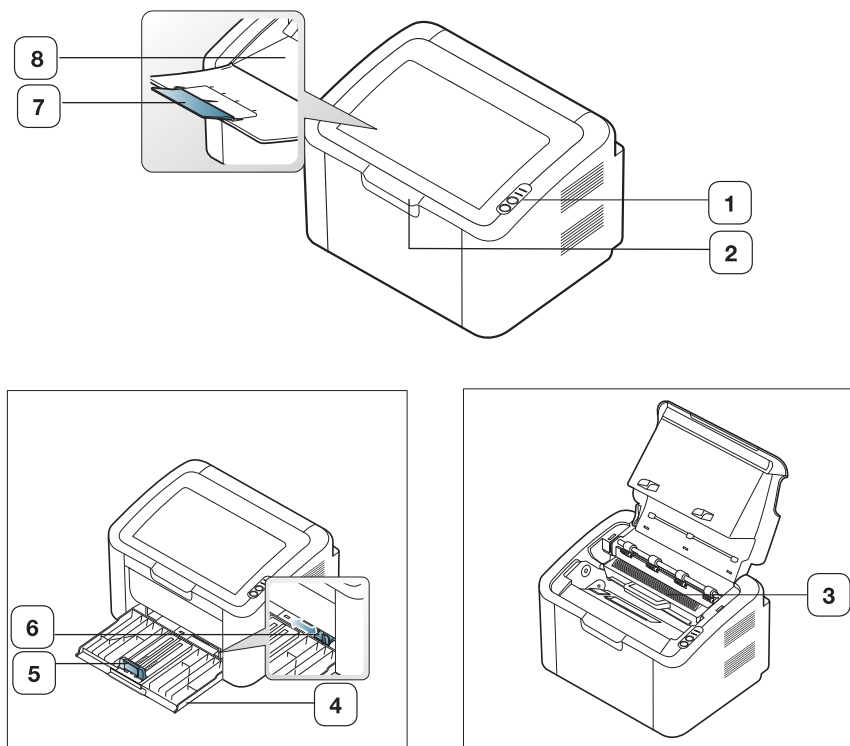

This illustration may differ from your machine depending on its model.

- |   |                 |   |                         |
|---|-----------------|---|-------------------------|
| 1 | Control panel   | 5 | Paper length guide      |
| 2 | Top cover       | 6 | Paper width guides      |
| 3 | Toner cartridge | 7 | Output support          |
| 4 | Tray            | 8 | Output tray (face down) |

## Rear view

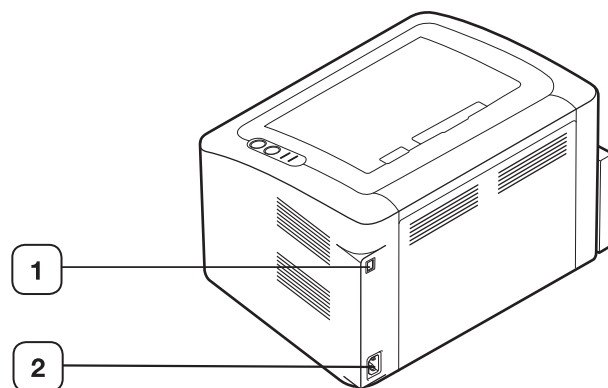

This illustration may differ from your machine depending on its model.

---

1 USB port

---

2 Power cord receptacle

---

## Control panel overview

This control panel may differ from your machine depending on the model.

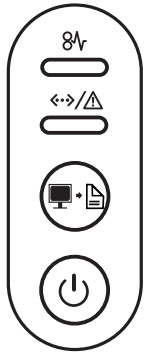

1	8v	Jam	Shows the status of paper jams in your machine (See "Understanding the status LED" on page 20).
2	↔/Δ	Online/Error	Shows the status of your machine (See "Understanding the status LED" on page 20).
3	🖨️📄	Print Screen	Prints the displayed screen of your monitor. (See "(Print screen) button" on page 20.)
4	🔌	Power	You can turn the power on and off with this button. (See "(Power) button" on page 20.)

## Understanding the status LED

The color of the LEDs indicates the machine's current status.

LED	Status		Description
Jam (8V)	Orange	On	A paper jam has occurred. (See "Clearing paper jams" on page 49.)
Online /Error (↔)/△	Off		<ul style="list-style-type: none"> <li>The machine is off-line.</li> </ul>
	Green	On	<ul style="list-style-type: none"> <li>The machine is in power saver mode.</li> <li>The machine is on-line and can receive data from the computer.</li> </ul>
		Blinking	<ul style="list-style-type: none"> <li>When the LED slowly blinks, the machine is receiving data from the computer.</li> <li>When the LED rapidly blinks, the machine is printing data.</li> </ul>
	Red	On	<ul style="list-style-type: none"> <li>The cover is opened. Close the cover.</li> <li>There is no paper in the tray. Load paper in the tray.</li> <li>The machine has stopped due to a major error.</li> <li>Your system has some problems. If this problem occurs, contact a service representative.</li> <li>A toner cartridge has almost reached its estimated cartridge life<sup>a</sup>. It is recommended to replace the toner cartridge. (See "Replacing the toner cartridge" on page 58.)</li> </ul>
Blinking		<ul style="list-style-type: none"> <li>A minor error has occurred and the machine is waiting for the error to be cleared. When the problem is cleared, the machine resumes printing.</li> <li>A small amount of toner is left in the cartridge. The estimated cartridge life<sup>a</sup> of toner is close. Prepare a new cartridge for replacement. You may temporarily increase the printing quality by redistributing the toner (See "Redistributing toner" on page 49).</li> <li>The machine is printing in manual feed mode or in manual duplex mode.</li> <li>The machine is canceling a print job.</li> </ul>	

a. Estimated cartridge life means the expected or estimated toner cartridge life, which indicates the average capacity of print-outs and is designed pursuant to ISO/IEC 19752. The number of pages may be affected by operating environment, printing interval, media type, and media size. Some amount of toner may remain in the cartridge even when red LED is on and the printer stops printing.

 Samsung does not recommend using a non-genuine Samsung toner cartridge such as one that is refilled or remanufactured. Samsung cannot guarantee a non-genuine Samsung toner cartridge's quality. Service or repair required as a result of using non-genuine Samsung toner cartridges will not be covered under the machine warranty.

 All printing errors will appear in the Printer Status(Windows) or Smart Panel(Linux, Mac OS X) program window. If the problem persists, contact a service representative.

## Introducing the useful buttons

 (Print screen) button

By pressing the , you can:

Function	Description
<b>Printing the active window</b>	Press this button and the green LED will start blinking. When the green LED stops blinking, release the button.
<b>Printing the whole monitor screen</b>	Press this button and the green LED will start blinking. Release the button while it's blinking.
<b>Printing a configuration sheet</b>	In the ready mode, press and hold this button for about 10 seconds until the green LED blinks slowly, and release. (See "Printing a configuration sheet" on page 22.)
<b>Supplies info report</b>	In the ready mode, press and hold this button for about 15 seconds until the green LED blinks rapidly, and release.
<b>Manual print</b>	Press this button each time you load a sheet of paper in the tray if you have selected <b>Manual Feeder</b> for <b>Source</b> in your printer driver.

 • **Print Screen** can only be used in the Windows and Macintosh operating systems.

- When printing the active window/whole monitor screen using the print screen button, the machine may use more toner depending on what is being printed.
- You can only use this function if the machine's Samsung Easy Printer Manager or Smart Panel program is installed.

 (Power) button

By pressing the , you can:

Function	Description
<b>Power On/Off</b>	Press this button to turn the power on or off.
<b>Cancel print job</b>	<p>During printing, press this button once. The print job is cleared from both the machine and the computer and then the machine returns to the ready mode. This may take some time depending on the size of the print job.</p> <p> If you press this button for more than 2 seconds, the power goes off.</p>

## Turning on the machine

1. Plug in the power cord.
2. Press  on the control panel.

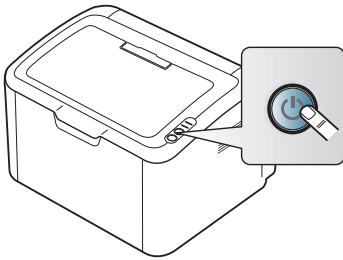

-  If you want to turn the power off, press and hold this button for about 2 seconds.

# getting started

This chapter gives you step-by-step instructions for setting up the USB connected machine and software.

## This chapter includes:

- Setting up the hardware
- Printing a configuration sheet
- Supplied software

## Setting up the hardware

This section shows the steps to set up the hardware, as is explained in the Quick Install Guide. Make sure you read the Quick Install Guide first and follow the steps below:

### Location

#### 1. Select a stable location.

Select a level, stable place with adequate space for air circulation. Allow extra space for opening cover(s) and tray(s).

The area should be well ventilated and away from direct sunlight or sources of heat, cold, and humidity. Do not set the machine close to the edge of your desk or table.

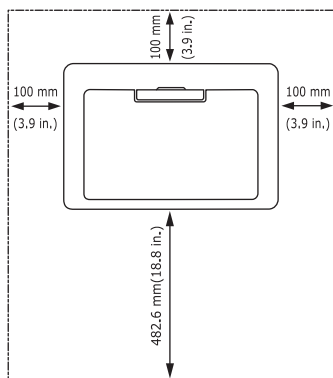

Printing is suitable for altitudes under 1,000 m (3,281 ft).

Place the machine on a flat, stable surface so that there is no incline greater than 2 mm (0.08 inch). Otherwise, printing quality may be affected.

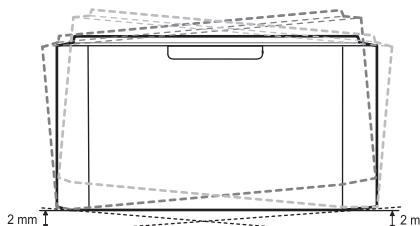

2. Unpack the machine and check all the enclosed items.
3. Remove tape holding the machine securely.
4. Install the toner cartridge.
5. Load paper. (See "Loading paper in the tray" on page 29.)
6. Make sure that all cables are connected to the machine.
7. Turn the machine on. (See "Turning on the machine" on page 21.)

- System requirements
- Installing USB connected machine's driver
- Sharing your machine locally



This machine will not operate when the power main fails.

## Printing a configuration sheet

Print a configuration page to make sure that the machine is operating properly.

### To print a configuration page:

In the ready mode, press and hold  for about 10 seconds until the green LED blinks slowly, and release.

## Supplied software

After you have set up your machine and connected it to your computer, you must install the printer software. If you are a Windows or Macintosh OS user, install the software from the supplied CD and if you are a Linux OS user, download the software from the Samsung website ([www.samsung.com/printer](http://www.samsung.com/printer)) and install.



Machine software is occasionally updated for reasons like the release of new operating system and etc. If needed, download the latest version from the Samsung website ([www.samsung.com/printer](http://www.samsung.com/printer)).

OS	Contents
Windows	<ul style="list-style-type: none"><li>• <b>Printer driver:</b> Use this driver to take full advantage of your machine's features.</li><li>• <b>Easy Printer Manager:</b> This program combines device settings as well as printing environments, settings/actions and launching. All of these features provide a gateway to conveniently use your Samsung machine.</li><li>• <b>Printer Status:</b> This program monitors and informs you of the machine status.</li></ul>
Macintosh	<ul style="list-style-type: none"><li>• <b>Printer Driver:</b> Use this driver to take full advantage of your machine's features.</li><li>• <b>Smart Panel:</b> This program allows you to monitor the machine's status.</li></ul>
Linux	<ul style="list-style-type: none"><li>• <b>Unified Linux Driver:</b> Use this driver to take full advantage of your machine's features.</li><li>• <b>Smart Panel:</b> This program allows you to monitor the machine's status and alerts you when an error occurs during printing.</li></ul>



## System requirements

Before you begin, ensure that your system meets the following requirements:

### Windows

Your machine supports the following Windows operating systems.

OPERATING SYSTEM	Requirement (recommended)		
	CPU	RAM	free HDD space
<b>Windows® 2000</b>	Intel® Pentium® II 400 MHz (Pentium III 933 MHz)	64 MB (128 MB)	600 MB
<b>Windows® XP</b>	Intel® Pentium® III 933 MHz (Pentium IV 1 GHz)	128 MB (256 MB)	1.5 GB
<b>Windows Server® 2003</b>	Intel® Pentium® III 933 MHz (Pentium IV 1 GHz)	128 MB (512 MB)	1.25 GB to 2 GB
<b>Windows Server® 2008</b>	Intel® Pentium® IV 1 GHz (Pentium IV 2 GHz)	512 MB (2048 MB)	10 GB
<b>Windows Vista®</b>	Intel® Pentium® IV 3 GHz	512 MB (1024 MB)	15 GB
<b>Windows® 7</b>	Intel® Pentium® IV 1 GHz 32-bit or 64-bit processor or higher	1 GB (2 GB)	16 GB
	<ul style="list-style-type: none"> <li>Support for DirectX® 9 graphics with 128 MB memory (to enable the Aero theme).</li> <li>DVD-R/W Drive</li> </ul>		
<b>Windows Server® 2008 R2</b>	Intel® Pentium® IV 1 GHz (x86) or 1.4 GHz (x64) processors (2 GHz or faster)	512 MB (2048 MB)	10 GB

- Internet Explorer 5.0 or higher is the minimum requirement for all Windows operating systems.
- Windows Terminal Services** is compatible with this machine.

### Macintosh

OPERATING SYSTEM	Requirements (recommended)		
	CPU	RAM	free HDD space
<b>Mac OS X 10.3 ~ 10.4</b>	<ul style="list-style-type: none"> <li>Intel® Processors</li> <li>PowerPC G4/ G5</li> </ul>	<ul style="list-style-type: none"> <li>128 MB for a PowerPC based Mac (512 MB)</li> <li>512 MB for a Intel-based Mac (1 GB)</li> </ul>	1 GB

OPERATING SYSTEM	Requirements (recommended)		
	CPU	RAM	free HDD space
<b>Mac OS X 10.5</b>	<ul style="list-style-type: none"> <li>Intel® Processors</li> <li>867 MHz or faster Power PC G4/ G5</li> </ul>	512 MB (1 GB)	1 GB
<b>Mac OS X 10.6</b>	<ul style="list-style-type: none"> <li>Intel® Processors</li> </ul>	1 GB (2 GB)	1 GB

### Linux

Item	Requirements
<b>Operating system</b>	RedHat Enterprise Linux WS 4, 5 Fedora 4, 5, 6, 7, 8, 9, 10, 11, 12 SuSE Linux 10.0, 10.1 OpenSuSE 10.2, 10.3, 11.0, 11.1, 11.2 Mandriva 2005, 2006, 2007, 2008, 2009, 2009.1 Ubuntu 5.04, 5.10, 6.06, 6.10, 7.04, 7.10, 8.04, 8.10, 9.04, 9.10, 10.04 SuSE Linux Enterprise Desktop 10, 11 Debian 4.0, 5.0
<b>CPU</b>	Pentium IV 2.4 GHz (Intel Core™2)
<b>RAM</b>	512 MB (1024 MB)
<b>Free HDD space</b>	1 GB (2 GB)

### Installing USB connected machine's driver

A locally connected machine is a machine directly connected to your computer by a USB cable.

- Only use a USB cable no longer than 3 m (10 ft.).

### Windows

You can install the machine software using the typical or custom method. The following steps are recommended for most users who use a machine directly connected to your computer. All components necessary for machine operations will be installed.

- Make sure that the machine is connected to the computer and powered on.
  - If the **"Found New Hardware Wizard"** window appears during the installation procedure, click **Cancel** to close the window.
- Insert the supplied software CD into your CD-ROM drive.
  - The software CD should automatically run and an installation window will appear.
  - If the installation window does not appear, click **Start** and then **Run**. Type X:\Setup.exe, replacing "X" with the letter which represents your CD-ROM Drive. Click **OK**.
  - If you use Windows Vista, Windows 7 and Windows 2008 Server R2 click **Start > All programs > Accessories > Run**. Type X:\Setup.exe replacing "X" with the letter which represents your CD-ROM Drive and click **OK**.
  - If the **AutoPlay** window appears in Windows Vista, Windows 7 and

Windows 2008 Server R2, click **Run Setup.exe** in **Install** or **run program** field, and click **Continue** or **Yes** in the **User Account Control** windows.

3. Select **Install now**.

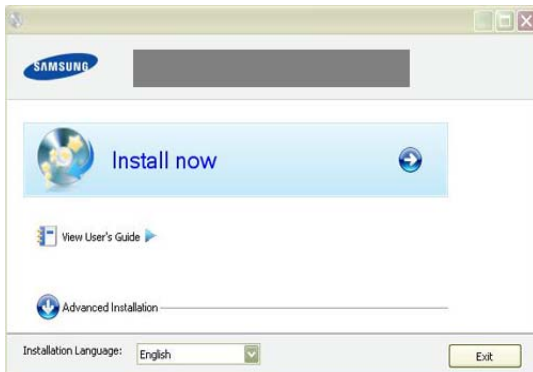

If necessary, select a language from the drop-down list.

 The **Advanced Installation** has an option, **Custom Installation**. The **Custom Installation** allows you to select the machine's connection and choose individual component to install. Follow the instruction on the window.

4. Read the **License Agreement**, and select **I accept the terms of the License Agreement**. Then, click **Next**.

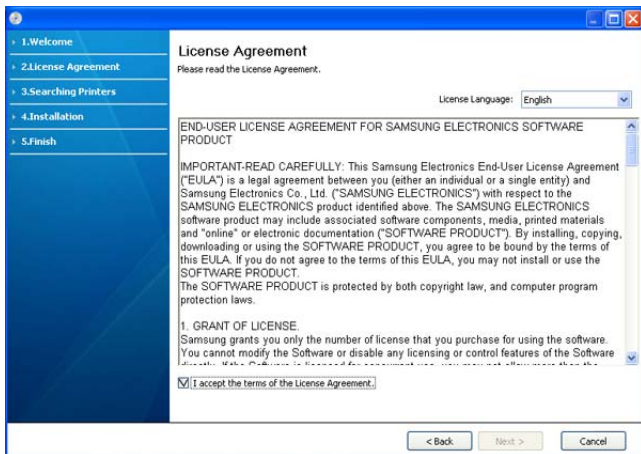

The software searches for the machine.

 If your machine is not connected to the computer, the following

window will appear.

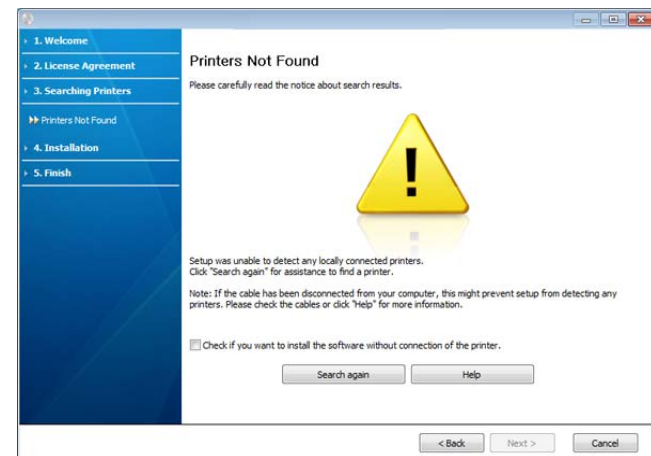

- After connecting the machine, click **Next**.
- **Check if you want to install the software without connecting the printer to the network or locally.**
  - Check this option to install the software without a machine connected. In this case, the print a test page window will be skipped.
- **Search again**
  - Press this button to research for the connected machine.
  - When you click this button, the firewall notice window appears; Turn off the firewall and click **Search again**. For Windows operating system, click **Start > Control Panel > Windows Firewall**, and inactivate this option. Then click **Next** in the **Firewall Notice** window. Turn off the firewall from the third party's program beside the operating system. Refer to the manual provided by individual programs.
- **Help**
  - This help button gives detailed information about how to connect the machine.

5. The searched machines will be shown on the screen. Select the one you wish to use and click **Next**.

 If the software searched only one machine, the confirmation window appears.

6. After the installation is finished, a window asking you to print a test page appears. If you want to print a test page, click **Print a test page**. Otherwise, just click **Next** and skip to step 8.

7. If the test page prints out correctly, click **Yes**.

If not, click **No** to reprint it.

8. If you want to register your machine on Samsung web site, click **On-line Registration**.

9. Click **Finish**.

 If the printer driver does not work properly, follow the steps below to uninstall and reinstall the driver.

- a) Make sure that the machine is connected to your computer and powered on.
- b) From the **Start** menu, select **Programs** or **All Programs > Samsung Printers > your printer driver name > Uninstall**.
- c) Select the necessary option and follow the instructions in the window.

- d) After uninstalling the printer driver, reinstall it (see “Installing USB connected machine’s driver” on page 23).

## Macintosh

The software CD that came with your machine provides you with the PPD file that allows you to use the CUPS driver or Apple LaserWriter driver (only available when you use a machine which supports the PostScript driver) for printing on a Macintosh computer.

1. Make sure that the machine is connected to your computer and powered on.
2. Insert the supplied software CD into your CD-ROM drive.
3. Double-click the CD-ROM icon that appears on your Macintosh desktop.
4. Double-click the **MAC\_Installer** folder.
5. Double-click the **Installer OS X** icon.
6. Enter the password and click **OK**.
7. The Samsung Installer window opens. Click **Continue**.
8. Read the license agreement and click **Continue**.
9. Click **Agree** to agree to the license agreement.
10. Select **Easy Install** and click **Install**. **Easy Install** is recommended for most users. All components necessary for machine operations will be installed.  
If you select **Custom Install**, you can choose individual components to install.
11. When the message which warns that all applications will close on your computer appears, click **Continue**.
12. After the installation is finished, click **Quit**.
13. Open the **Applications** folder > **Utilities** > **Print Setup Utility**.
  - For Mac OS X 10.5~10.6, open the **Applications** folder > **System Preferences** and click **Print & Fax**.
14. Click **Add** on the **Printer List**.
  - For Mac OS X 10.5~10.6, click the “+” icon; a display window will pop up.
15. For Mac OS X 10.3, select the **USB** tab.
  - For Mac OS X 10.4, click **Default Browser** and find the USB connection.
  - For Mac OS X 10.5~10.6, click **Default** and find the USB connection.
16. For Mac OS X 10.3, if Auto Select does not work properly, select **Samsung** in **Printer Model** and your machine name in **Model Name**.
  - For Mac OS X 10.4, if Auto Select does not work properly, select **Samsung** in **Print Using** and your machine name in **Model**.
  - For Mac OS X 10.5~10.6, if Auto Select does not work properly, select **Select a driver to use...** and your machine name in **Print Using**.

Your machine appears on the **Printer List**, and is set as the default machine.

17. Click **Add**.

 If the printer driver does not work properly, uninstall the driver and reinstall it.

Follow steps below to uninstall the driver for Macintosh.

- a) Make sure that the machine is connected to your computer and powered on.
- b) Insert the supplied software CD into your CD-ROM drive.
- c) Double-click CD-ROM icon that appears on your Macintosh desktop.
- d) Double-click the **MAC\_Installer** folder.
- e) Double-click the **Installer OS X** icon.
- f) Enter the password and click **OK**.

- g) The Samsung Installer window opens. Click **Continue**.
- h) Select **Uninstall** and click **Uninstall**.
- i) When the message which warns that all applications will close on your computer appears, Click **Continue**.
- j) When the uninstall is done, click **Quit**.

## Linux

You need to download Linux software packages from the Samsung website to install the printer software.

Follow the steps below to install the software.

### Installing the Unified Linux Driver

1. Make sure that the machine is connected to your computer and powered on.
2. When the **Administrator Login** window appears, type in root in the **Login** field and enter the system password.
  -  You must log in as a super user (root) to install the machine software. If you are not a super user, ask your system administrator.
3. From the Samsung website, download the Unified Linux Driver package to your computer.
4. Right click the **Unified Linux Driver** package and extract the package.
5. Double click **cdroot > autorun**.
6. When the welcome screen appears, click **Next**.



7. When the installation is complete, click **Finish**.

The installation program added the Unified Driver Configurator desktop icon and the Unified Driver group to the system menu for your convenience. If you have any difficulties, consult the on screen help that is available through your system menu or from the driver package Windows applications, such as **Unified Driver Configurator**.

 If the printer driver does not work properly, uninstall the driver and reinstall it.

Follow the steps below steps to uninstall the driver for Linux.

- a) Make sure that the machine is connected to your computer and powered on.
- b) When the **Administrator Login** window appears, type in “root” in the **Login** field and enter the system password.  
You must log in as a super user (root) to uninstall the printer driver. If you are not a super user, ask your system administrator.
- c) Click the icon at the bottom of the desktop. When the Terminal screen appears, type in:  
**[root@localhost root]#cd /opt/Samsung/mfp/uninstall/**

```
[root@localhost uninstall]#./uninstall.sh
```

- d) Click **Uninstall**.
- e) Click **Next**.
- f) Click **Finish**.

## Installing the SmartPanel

1. Make sure that the machine is connected to your computer and powered on.
2. When the **Administrator Login** window appears, type in root in the **Login** field and enter the system password.

 You must log in as a super user (root) to install the machine software. If you are not a super user, ask your system administrator.

3. From the Samsung website, download the **Smart Panel** package to your computer.
4. Right click the Smart Panel package and extract the package.
5. Double click **cdroot > Linux > smartpanel > install.sh**.

## Sharing your machine locally

Follow the steps below to set up computers to share your machine locally. If the Host computer is directly connected to the machine by a USB cable and is also connected to the local network environment, the client computer connected to the local network can use the shared machine through the host computer to print.

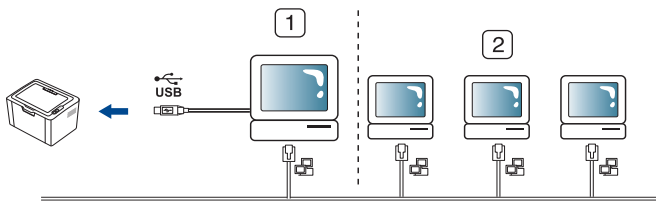

1	Host computer	A computer which is directly connected to the machine by USB cable.
2	Client computers	Computers which use the machine shared through the host computer.

## Windows

### Setting up a host computer

1. Install your printer driver (See "Installing USB connected machine's driver" on page 23).
2. Click the Windows **Start** menu.
3. For Windows 2000, select **Settings > Printers**.
  - For Windows XP/2003, select **Printers and Faxes**.
  - For Windows 2008/Vista, select **Control Panel > Hardware and Sound > Printers**.
  - For Windows 7, select **Control Panel > Hardware and Sound > Devices and Printers**.
  - For Windows Server 2008 R2, select **Control Panel > Hardware > Devices and Printers**.
4. Right-click the printer icon.
5. For Windows XP/2003/2008/Vista, press **Properties**.  
For Windows 7 and Windows Server 2008 R2, from context menus, select the **Printer properties**.

 If **Printer properties** item has a ► mark, you can select other printer drivers connected with the selected printer.

6. Select the **Sharing** tab.
7. Check **Change Sharing Options**.
8. Check the **Share this printer** checkbox.
9. Fill in the **Share Name** field. Click **OK**.

### Setting up a client computer

1. Install your printer driver (See "Installing USB connected machine's driver" on page 23).
2. Click the Windows **Start** menu.
3. Select **All programs > Accessories > Windows Explorer**.
4. Enter the IP address of the host computer in the address bar and press Enter in your keyboard.



 In case host computer requires a **User name** and **Password**, fill in User ID and password of the host computer account.

5. Right click the printer icon you want to share and select **Connect**.
6. If a set up complete message appears, click **OK**.
7. Open the file you want to print and start printing.

## Macintosh

 The following steps are for Mac OS X 10.5~10.6. Refer to Mac Help for other OS versions.

### Setting up a host computer

1. Install your printer driver. (See "Macintosh" on page 25.)
2. Open the **Applications** folder > **System Preferences** and click **Print & Fax**.
3. Select the printer to share in the **Printers list**.
4. Select **Share this printer**.

### Setting up a client computer

1. Install your printer driver. (See "Macintosh" on page 25.)
2. Open the **Applications** folder > **System Preferences** and click **Print & Fax**.
3. Click the "+" icon.  
A display window showing the name of your shared printer appears.
4. Select your machine and click **Add**.

# basic setup

---

After installation is complete, you may want to set the machine's default settings. Refer to the next section if you would like to set or change values. This chapter gives you step-by-step instructions for setting up the machine.

**This chapter includes:**

- Setting the default tray and paper

## Setting the default tray and paper

---

You can select the tray and paper you would like to keep using for printing job.

### From your computer

#### Windows

1. Click the Windows **Start** menu.
2. For Windows 2000, select **Settings > Printers**.
  - For Windows XP/2003, select **Printer and Faxes**.
  - For Windows 2008/Vista, select **Control Panel > Hardware and Sound > Printers**.
  - For Windows 7, select **Control Panel > Hardware and Sound > Devices and Printers**.
  - For Windows Server 2008 R2, select **Control Panel > Hardware > Devices and Printers**.
3. Right-click on your machine.
4. For Windows XP/2003/2008/Vista, press **Printing Preferences**.  
For Windows 7 and Windows Server 2008 R2, from context menus, select the **Printing Preferences**.



If **Printing Preferences** item has a ► mark, you can select other printer drivers connected with the selected printer.

5. Click **Paper** tab.
6. Select tray and its options, such as paper size and type.
7. Press **OK**.



If you want to use special-sized paper such as a billing paper, select **Edit...** in the **Paper** tab in the **Printing Preferences**. (See "Opening printing preferences" on page 34.)

#### Macintosh

Macintosh does not support this function. Macintosh users need to change the default setting manually each time they want to print using other settings.

1. Open a Macintosh application and select the file you want to print.
2. Open the **File** menu and click **Print**.
3. Go to **Paper Feed** pane.
4. Set appropriate tray from which you want to print.
5. Go to **Paper** pane.
6. Set paper type to correspond to the paper loaded in the tray from which you want to print.
7. Click **Print** to print.

#### Linux

1. Open **Terminal Program**.
2. When the Terminal screen appears, type in the following:  
`[root@localhost root]# lpr <FileName>`
3. Select **Printer** and click **Properties...**
4. Click on the **Advanced** tab.
5. Select the tray (source) and its options, such as paper size and type.
6. Press **OK**.

## Using The power saving feature

---

When you will not be using the machine for a while, you can use this feature to save power.

1. Install the driver (See "Installing USB connected machine's driver" on page 23).
2. Select **Start > Programs or All Programs > Samsung Printers > Samsung Easy Printer Manager > Samsung Easy Printer Manager**.
3. Select **Device Settings > Machine > Power Save**.
4. Select a time you want from the drop-down list.
5. Click **Save**.



# media and tray

This chapter provides information on how to load print media into your machine.

## This chapter includes:

- Selecting print media
- Changing the tray size
- Loading paper in the tray

## Selecting print media

You can print on a variety of print media, such as plain paper, envelopes, labels, and transparencies. Always use print media that meets the guidelines for use with your machine and from the appropriate tray.

### Guidelines for selecting the print media

Print media that does not meet the guidelines outlined in this user's guide may cause the following problems:

- Poor print quality
- Increased paper jams
- Premature wear on the machine.
- Permanent fuser damage, not covered under warranty.

Properties, such as weight, composition, grain, and moisture content, are important factors that affect the machine's performance and the output quality. When you choose print materials, consider the following:

- The type, size and weight of the print media for your machine are described in print media specifications. (See "Print media specifications" on page 62.)
- Desired outcome: The print media you choose should be appropriate for your project.
- Brightness: Some print media are whiter than others and produce sharper, more vibrant images.
- Surface smoothness: The smoothness of the print media affects how crisp the printing looks on the paper.

-  • Some print media may meet all of the guidelines in this section and still not produce satisfactory results. This may be the result of the sheets characteristics, improper handling, unacceptable temperature and humidity levels, or other variables over which cannot be controlled.
- Before purchasing large quantities of print media, ensure that it meets the specifications in this user's guide and that it meets your output requirements.

-  • Using print media that does not meet these specifications may cause problems, requiring repairs. Such repairs are not covered by the warranty or service agreements.

The amount of paper put into the tray may differ according to media type used. (See "Print media specifications" on page 62.)

- Using inflammable print media can cause a fire.
- Use designated print media (See "Print media specifications" on page 62).

-  The use of inflammable media or foreign materials left in the printer may lead to overheating of the unit and, in rare cases may cause a fire.

- Printing on special media
- Changing the tray size

## Media sizes supported in each mode

Mode	Size	Type	Source
<b>Simplex printing</b>	For details about paper size, see "Print media specifications" on page 62.	For details about paper type, see "Print media specifications" on page 62.	Tray
<b>Duplex printing (Manual)<sup>a</sup></b>	Letter, A4, Legal, US Folio, Oficio	Plain, Color, Preprinted, Recycled, Bond, Archive	Manual feeding in the tray

a. 75 to 90 g/m<sup>2</sup> (20~24 lbs bond) only (See "Print media specifications" on page 62).

## Changing the tray size

The tray is preset to Letter or A4 size, depending on your country. To change the size, you need to adjust the paper guides.

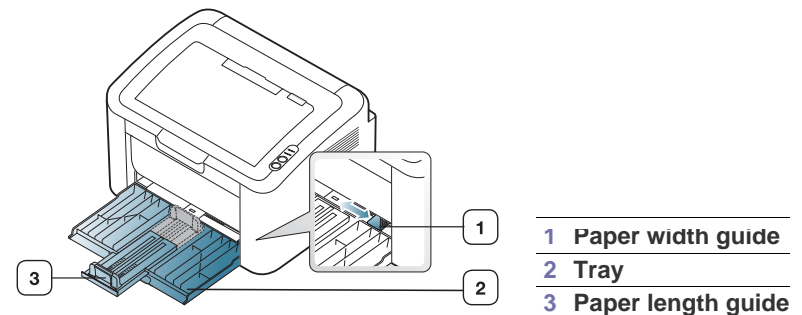



1. Open front cover and pinch the paper length guide and pull it out to extend the tray.

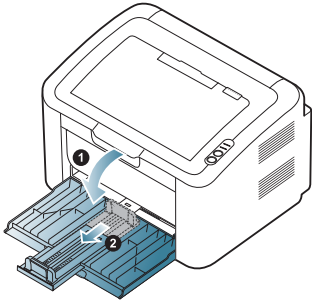

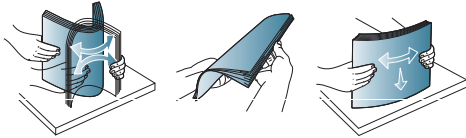

 Because the machine is very light, it can move when you open and close the tray or install and remove the toner cartridge. Be careful not to move the machine when performing these tasks.

2. Flex or fan the edge of the paper stack to separate the pages before loading the paper. Insert the paper into the tray.



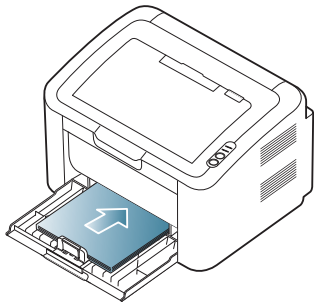

3. Load paper with the print side facing up. Make sure that all four corners are flat in the tray.

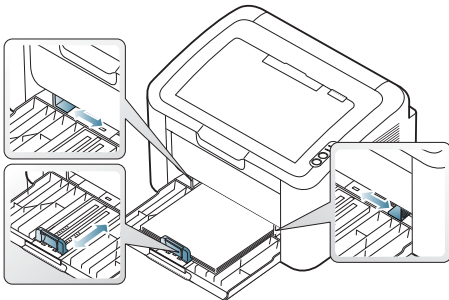

 Do not overload the tray with paper. Otherwise, it may cause paper jams.

4. Pinch the paper length guide to adjust the guide so that it is flush against the rear edge of the paper; then pinch the paper width guides so they are flush against the sides of the paper.



- 
- Do not push the paper width guide too far causing the media to warp.
  - Do not use a paper with more than 6 mm (0.24 inch.) curl.
  - If you do not adjust the paper width guide, it may cause paper

jams.

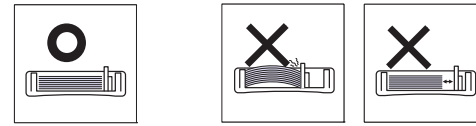

## Loading paper in the tray

### Tray

1. Open the front cover, pinch the paper length guide and pull it out to extend the tray. Then, adjust the tray size to the media size you are loading. (See "Changing the tray size" on page 28.)
2. Flex or fan the edge of the paper stack to separate the pages before loading papers.

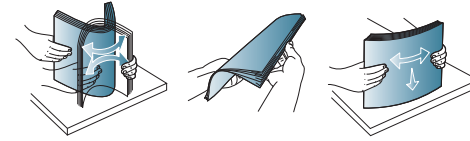

3. Place the paper with the side you want to print facing up.

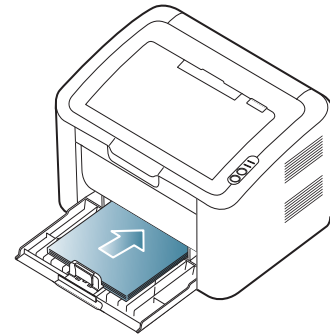

When you print a document, set the paper type and size for the tray. For information about setting the paper type and size on the control panel (See "Setting the default tray and paper" on page 27).

- 
- If you experience problems with paper feeding, check whether the paper meets the media specifications. Then, try placing one sheet at a time in tray (See "Print media specifications" on page 62, "Printing on special media" on page 30).
  - The settings made from the machine driver override the settings on the control panel.

### Manual feeding in the tray

The tray can hold special sizes and types of print material, such as postcards, note cards, and envelopes. It is useful for single page printing on letterhead or colored paper.

#### Tips on using the manual feeding method

- If you select **Paper > Source > Manual Feeder** from your printer driver, you need to press  each time you print a page. Load only one type, size and weight of print media at a time in the tray.
- To prevent paper jams, do not add media while printing.
- Print media should be loaded face up with the top edge going into the tray first and be placed in the center of the tray.

- Always load the use recommended print media to avoid paper jams and print quality problems. (See "Print media specifications" on page 62.)
  - Flatten any curl on postcards, envelopes, and labels before loading them into the tray.
1. Load the paper in the tray.

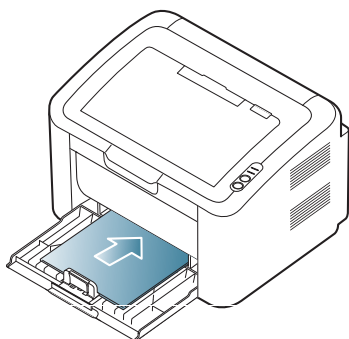

- When printing on special media, you must follow the loading guideline. (See "Printing on special media" on page 30.)
  - When paper does not feed well while printing, gently push the paper in manually until it starts feeding automatically.
2. Squeeze the tray paper width guides and adjust them to the width of the paper. Do not force them too much, or the paper will bend resulting in a paper jam or skew.
  3. Open the output support.
  4. To print from an application, open the application and open the print menu.
  5. Open **Printing Preferences**. (See "Opening printing preferences" on page 34.)
  6. Click on the **Paper** tab in **Printing Preferences**, and select an appropriate paper type.
    - For example, if you want to use a label, set the paper type to **Label**.
  7. Select **Manual Feeder** in paper source, then press **OK**.
  8. Start printing.
    - If you are printing multiple pages, load the next sheet after the first page prints out, and press the **Next** button. Repeat this step for every page to be printed.

## Printing on special media

The table below shows the available special media for printing.

- When printing on a special media, we recommend you feed one paper at a time. Check the maximum input number of media for tray. (See "Print media specifications" on page 62.)

Types	tray	Manual feeding in tray <sup>a</sup>
Plain	•	•
Thick	•	•
Thin	•	•

Types	tray	Manual feeding in tray <sup>a</sup>
		•
Color		•
Preprinted		•
Recycled	•	•
Envelope		•
Transparency		•
Labels		•
CardStock		•
Bond		•
Archive	•	•

a. Load one paper at a time.

(•: supported, Blank: Not supported)

The following media types are shown in the **Printing Preferences**. This paper type option allows you to set the type of paper to be loaded in the tray. Selecting the appropriate media will let you get the best printout quality. Selecting inappropriate media can result in poor print quality.

- **Plain:** Normal plain paper. Select this type if your printing on 60 to 120 g/m<sup>2</sup> (16 to 32 lbs).
- **Thick:** 90 to 163 g/m<sup>2</sup> (24 to 43 lbs) thick paper.
- **Thin:** 60 to 70 g/m<sup>2</sup> (16 to 19 lbs) thin paper.
- **Cotton:** 75 to 90 g/m<sup>2</sup> (20 to 24 lbs) cotton paper.
- **Color:** 75 to 90 g/m<sup>2</sup> (20 to 24 lbs) color-back grounded paper.
- **Preprinted:** 75 to 90 g/m<sup>2</sup> (20 to 24 lbs) preprinted/letterhead paper.
- **Recycled:** 60 to 90 g/m<sup>2</sup> (16 to 24 lbs) recycled paper.

- When you use recycled paper, printouts might be wrinkled and/or jamming may occur due to excessive curl.

- **CardStock:** 105 to 163 g/m<sup>2</sup> (28 to 43 lbs) cardstock.
- **Envelope:** 75 to 90 g/m<sup>2</sup> (20 to 24 lbs) envelope.
- **Transparency:** 138 to 146 g/m<sup>2</sup> (37 to 39 lbs) transparency paper.
- **Labels:** 120 to 150 g/m<sup>2</sup> (32 to 40 lbs) labels.
- **Bond:** 105 to 120 g/m<sup>2</sup> (28 to 32 lbs) bond.
- **Archive:** 70 to 90 g/m<sup>2</sup> (19 to 24 lbs) If you need to keep the print-out for a long time, such as for archives.

## Envelopes

Successful printing on envelopes depends upon the quality of the envelopes.

To print on an envelope, the stamp area should be on the left side and the end of the envelope with the stamp area should enter the printer first in the center of the tray.

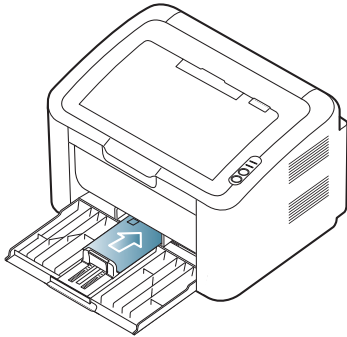

- When selecting envelopes, consider the following factors:
  - **Weight:** The weight of the envelope paper should not exceed 90 g/m<sup>2</sup> otherwise, jams may occur.
  - **Construction:** Prior to printing, envelopes should lie flat with less than 6 mm ( 0.24 inch.) of curl, and should not contain air.
  - **Condition:** Envelopes should not be wrinkled, nicked, nor damaged.
  - **Temperature:** Use envelopes that are compatible with the heat and pressure of the machine during operation.
- Use only well-constructed envelopes with sharp-and well-creased folds.
- Do not use stamped envelopes.
- Do not use envelopes with clasps, snaps, windows, coated lining, self-adhesive seals, or other synthetic materials.
- Do not use damaged or poorly made envelopes.
- Be sure the seam at both ends of the envelope extends all the way to the corner of the envelope.

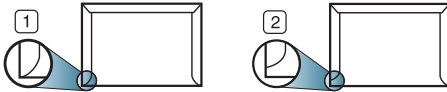

- 1 Acceptable**  
**2 Unacceptable**

- Envelopes with a peel-off adhesive strip or with more than one flap that folds over to seal must use adhesives compatible with the machine's fusing temperature about 170°C (338 °F) for 0.1 second. The extra flaps and strips might cause wrinkling, creasing, or jams, and may even damage the fuser.
- For the best print quality, position margins no closer than 15 mm ( 0.59 inch.) from the edges of the envelope.
- Avoid printing over the area where the envelope's seams meet.

## Transparencies

To avoid damaging the machine, use only transparencies designed for laser printers.

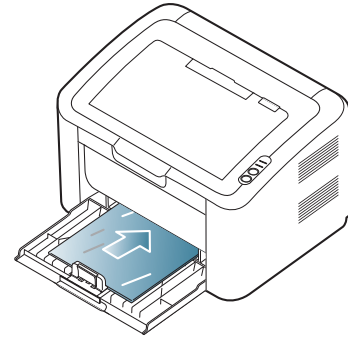

- Transparencies used in the machine must be able to withstand machine's fusing temperature.
- Place them on a flat surface after removing them from the machine.
- Do not leave unused transparencies on the paper tray for long periods of time. Dust and dirt may accumulate on them, resulting in spotty printing.
- To avoid smudging caused by fingerprints, handle transparencies carefully.
- To avoid fading, do not expose printed transparencies to prolonged sunlight.
- Ensure that transparencies are not wrinkled, curled, or have any torn edges.
- Do not use transparencies that separate from the backing sheet.
- To prevent transparencies from sticking to each other, do not let the printed sheets stack up as they are begin printed out.

## Labels

To avoid damaging the machine, use only labels designed for laser machines.

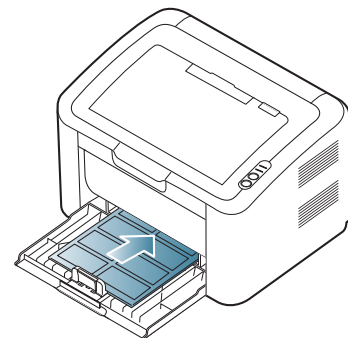

- When selecting labels, consider the following factors:
  - **Adhesives:** The adhesive material should be stable at your machine's fusing temperature (about 170°C (338 °F)).
  - **Arrangement:** Only use labels with no exposed backing between them. Labels can peel off sheets that have spaces between the labels, causing serious jams.
  - **Curl:** Prior to printing, labels must lie flat with no more than 13 mm (0.51 inch.) of curl in any direction.
  - **Condition:** Do not use labels with wrinkles, bubbles, or other indications of separation.
- Make sure that there is no exposed adhesive material between labels.

Exposed areas can cause labels to peel off during printing, which can cause paper jams. Exposed adhesive can also cause damage to machine components.

- Do not run a sheet of labels through the machine more than once. The adhesive backing is designed for only a single pass through the machine.
- Do not use labels that are separating from the backing sheet or are wrinkled, bubbled, or otherwise damaged.

### Card stock/Custom-sized paper

Postcards, cards and other custom-sized materials can be printed with this machine.

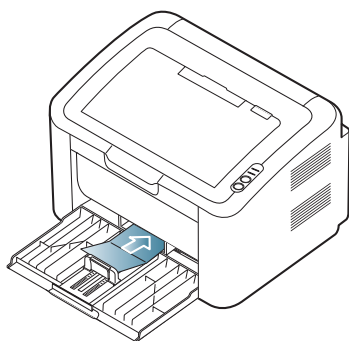

- Do not print on media smaller than 76 mm (3.00 inches) wide or 183 mm (7.20 inches) long.
- In software applications, set the margins at least 6.4 mm (0.25 inches) away from the edges of the material.

### Letterhead/Preprinted paper

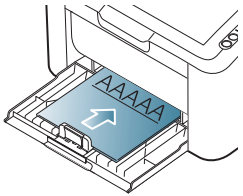
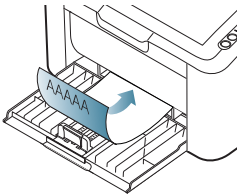
Single-sided	Double-sided
<b>Face up</b> 	<b>Face down</b> 

- Letterhead/ Preprinted paper must be printed with heat-resistant ink that will not melt, vaporize, or release hazardous emissions when subjected to the machine's fusing temperature (about 170°C(338 °F) for 0.1 second.
- Letterhead/ Preprinted paper ink must be non-flammable and should not adversely affect machine rollers.
- Forms and letterhead should be sealed in a moisture-proof wrapping to prevent changes during storage.
- Before you load letterhead/preprinted paper, verify that the ink on the paper is dry. During the fusing process, wet ink can come off preprinted paper, reducing print quality.

### Using the output support

-  The surface of the output tray may become hot if you print a large number of pages at once. Make sure that you do not touch the

surface, and do not allow children near it.

The printed pages stack on the output support, and the output support will help the printed pages to align. The printer sends printouts to the output tray by default.

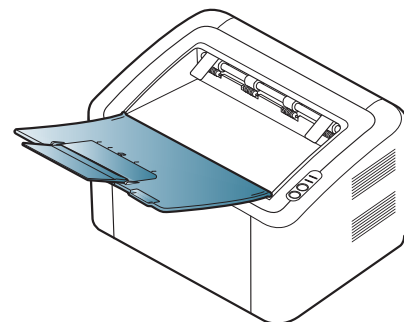

# printing

This chapter explains common printing tasks.

## This chapter includes:

- Printer driver features
- Basic printing
- Opening printing preferences
- Using help
- Using special print features

 The procedures in this chapter are mainly based on Windows XP.

## Printer driver features

Your printer drivers support the following standard features:

- Paper orientation, size, source, and media type selection
- Number of copies

In addition, you can use various special printing features. The following table shows a general overview of features supported by your printer driver:

 Some models or operating systems may not support some of the feature(s) in the following table.

## Printer driver





Feature	Windows
Print quality option	•
Poster printing	•
Multiple pages per sheet	•
Booklet printing (manual)	•
Fit to page printing	•
Reduce and enlarge printing	•
Different source for first page	•
Watermark	•
Overlay	•
Double-sided printing (manual)	•

(•: supported)

## Basic printing

Your machine allows you to print from various Windows, Macintosh, or Linux applications. The exact steps for printing a document may vary depending on the application you use.

-  Your **Printing Preferences** window that appears in this user's guide may differ depending on the machine in use. However, the composition of the **Printing Preferences** window is similar. Check the operating system(s) that are compatible with your machine. Refer to the OS compatibility section of Printer Specifications. (See "System requirements" on page 23.)

- Changing the default print settings
  - Setting your machine as a default machine
  - Printing to a file (PRN)
  - Macintosh printing
  - Linux printing
- When you select an option in **Printing Preferences**, you may see a warning mark, , or . An exclamation mark () means you can select that certain option but it is not recommended, and () mark means you cannot select that option due to the machine's settings or environment.

The following procedure describes the general steps required for printing from various Windows applications.

-  • Macintosh basic printing. (See "Macintosh printing" on page 38.)
- Linux basic printing. (See "Linux printing" on page 40.)

The following **Printing Preferences** window is for Notepad in Windows XP. Your **Printing Preferences** window may differ, depending on your operating system or the application you are using.

1. Open the document you want to print.
2. Select **Print** from the **File** menu. The **Print** window appears.
3. Select your machine from the **Select Printer** list.

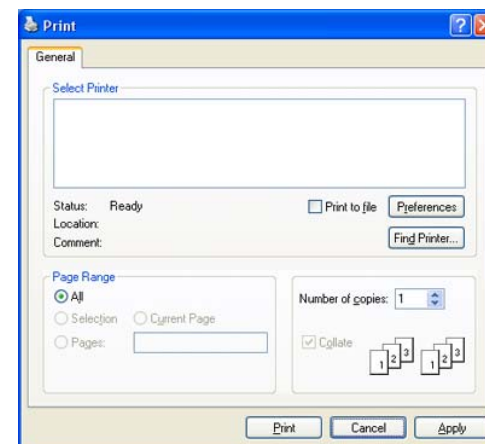

You can select the basic print settings, including the number of copies and the print range from within the **Print** window.

-  To take advantage of the printer features provided by your printer driver, click **Properties** or **Preferences** in the application's **Print** window to change the print setting. (See "Opening printing preferences" on page 34.)

4. To start the print job, click **OK** or **Print** in the **Print** window.

-  The **Samsung AnyWeb Print** will save your time for screen-captured images or printing the image. For Windows, click **Start > All programs > Samsung Printers > Samsung AnyWeb Print** to link the website where the tool is available for the download. For Macintosh, click **Application > Samsung > Samsung AnyWeb**

## Print.



### Canceling a print job

If the print job is waiting in a print queue or print spooler, cancel the job as follows:

1. Click the Windows **Start** menu.
2. For Windows 2000, select **Settings > Printers**.
  - For Windows XP/2003, select **Printer and Faxes**.
  - For Windows 2008/Vista, select **Control Panel > Hardware and Sound > Printers**.
  - For Windows 7, select **Control Panel > Hardware and Sound > Devices and Printers**.
  - For Windows Server 2008 R2, select **Control Panel > Hardware > Devices and Printers**.
3. For Windows 2000, XP, 2003, 2008 and Vista, double-click your machine.  
For Windows 7 and Windows Server 2008 R2, right click your printer icon > context menus > **See what's printing**.

 If **See what's printing** item has a ► mark, you can select other printer drivers connected with selected printer.

4. From the **Document** menu, select **Cancel**.

 You can also access this window by simply double-clicking the machine icon (  ) in the Windows task bar.

You can also cancel the current job by pressing  on the control panel.

### Opening printing preferences

You can preview the settings you selected on the upper right of the **Printing Preferences**.

1. Open the document you want to print.
2. Select **Print** from the file menu. The **Print** window appears.
3. Select your machine from the **Select Printer**.

4. Click **Properties** or **Preferences**.

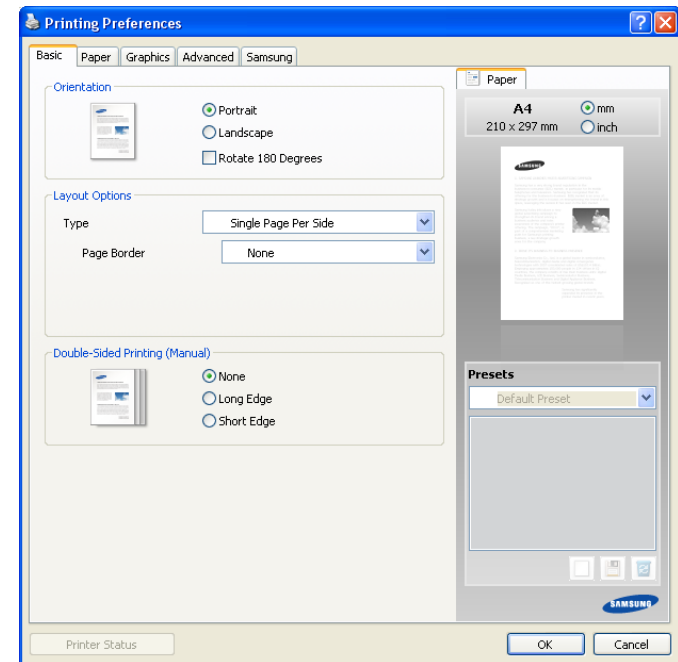

### Using a favorite setting

The **Presets** option, which is visible on each of the preferences tab except for the **Samsung** tab, allows you to save the current preferences for future use.

To save a **Presets** item:

1. Change the settings as needed on each tab.
2. Enter a name for the item in the **Presets** input box.

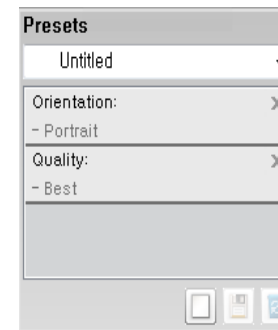

3. Click **Add**. When you save **Presets**, all current driver settings are saved. If you click **Add**, the **Add** button changes to the **Update** button. Select more options and click **Update**, settings will be added to the **Presets** you made. To use a saved setting, select it from the **Presets** drop-down list. The machine is now set to print according to the settings you have selected. To delete saved settings, select it from the **Presets** drop-down list and click **Delete**.

You can also restore the printer driver's default settings by selecting **Default Preset** from the **Presets** drop-down list.



## Using help

Click the question mark on the upper-right corner of the window and click on the topic you want to know about. Then a pop up window appears with information about that option's feature which is provided from the driver.



If you want to search information via a keyword, click the **Samsung** tab in the **Printing Preferences** window, and enter a keyword in the input line of the **Help** option. To get information about supplies, driver updates or registration and so on, click appropriate buttons.

## Using special print features

Special print features include:

- "Printing multiple pages on one sheet of paper" on page 35.
- "Printing posters" on page 35.
- "Printing booklets (Manual)" on page 35.
- "Printing on both sides of the paper (Manual)" on page 35.
- "Change percentage of your document" on page 36.
- "Fitting your document to a selected paper size" on page 36.
- "Using watermarks" on page 36.
- "Using overlays" on page 37.
- "Print quality options" on page 37.

### Printing multiple pages on one sheet of paper

You can select the number of pages to print on a single sheet of paper. To print more than one page per sheet, the pages will be reduced in size and arranged in the order you specify. You can print up to 16 pages on one sheet.

1. To change the print settings from your software application, access **Printing Preferences**. (See "Opening printing preferences" on page 34.)
2. Click the **Basic** tab, select **Multiple Pages Per Side** in the **Type** drop-down list.
3. Select the number of pages you want to print per sheet (2, 4, 6, 9, or 16) in the **Pages per Side** drop-down list.
4. Select the page order from the **Page Order** drop-down list, if necessary.
5. Check **Print Page Border** to print a border around each page on the sheet.
6. Click the **Paper** tab, select the **Size**, **Source**, and **Type**.
7. Click **OK** or **Print** until you exit the **Print** window.

### Printing posters

This feature allows you to print a single-page document onto 4, 9, or 16 sheets of paper, for the purpose of pasting the sheets together to form one poster-size document.

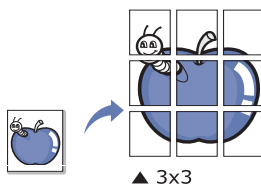

1. To change the print settings from your software application, access **Printing Preferences**. (See "Opening printing preferences" on page 34.)
2. Click the **Basic** tab, select **Poster Printing** in the **Type** drop-down list.
3. Select the page layout you want.  
Available layouts:
  - **Poster 2x2**: Document will be enlarged and be divided into 4 pages.
  - **Poster 3x3**: Document will be enlarged and be divided into 9 pages.
  - **Poster 4x4**: Document will be enlarged and be divided into 16 pages.
4. Select the **Poster Overlap** value. Specify **Poster Overlap** in millimeters or inches by selecting the radio button on the upper right of **Basic** tab to make it easier to paste the sheets together.

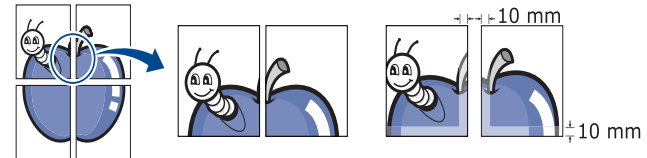



5. Click the **Paper** tab, select the **Size**, **Source**, and **Type**.
6. Click **OK** or **Print** until you exit the **Print** window.
7. You can complete the poster by pasting the sheets together.

### Printing booklets (Manual)

This feature prints your document on both sides of a paper and arranges the pages so that the paper can be folded in half after printing to produce a booklet.

-  If you want to make a booklet, you need to print on Letter, Legal, A4, US Folio, or Oficio sized print media.



1. To change the print settings from your software application, access the **Printing Preferences**. (See "Opening printing preferences" on page 34.)
2. Click the **Basic** tab, select **Booklet Printing** from the **Type** drop-down list.
3. Click the **Paper** tab, select the **Size**, **Source**, and **Type**.  
 The **Booklet Printing** option is not available for all paper sizes. In order to find out the available paper size for this feature, select the available paper size in the **Size** option on the **Paper** tab.  
If you select an unavailable paper size, this option can be automatically canceled. Select only available paper. (paper without  or  mark).
4. Click **OK** or **Print** until you exit the **Print** window.
5. After printing, fold and staple the pages.

### Printing on both sides of the paper (Manual)

You can print on both sides of a paper (duplex). Before printing, decide how you want your document oriented. You can use this feature with Letter, Legal, A4, US Folio, or Oficio sized paper. (See "Print media specifications" on page 62.)

-  We recommend not to print on both sides of special media, such as labels, envelopes, or thick paper. It may cause a paper jam or damage

the machine.

1. To change the print settings from your software application, access **Printing Preferences**. (See "Opening printing preferences" on page 34.)
2. Click the **Advanced** tab.
3. From the **Double-Sided Printing (Manual)** section, select the binding option you want.
  - **None**
  - **Long Edge:** This option is the conventional layout used in bookbinding.

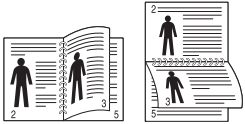

- **Short Edge:** This option is the conventional layout used in calendars.

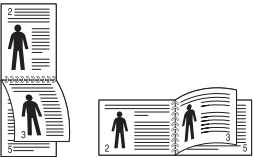

4. Click the **Paper** tab, select the **Size**, **Source**, and **Type**.
  5. Click **OK** or **Print** until you exit the **Print** window.
-  If your machine does not have a duplex unit, you should complete the printing job manually. The machine prints every other page of the document first. After that, a message appears on your computer. Follow the on-screen instructions to complete the printing job.

## Change percentage of your document

You can change the size of a document to appear larger or smaller on the printed page by typing in a percentage you want.

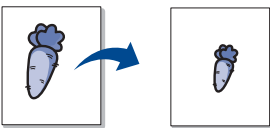

1. To change the print settings from your software application, access **Printing Preferences**. (See "Opening printing preferences" on page 34.)
2. Click the **Paper** tab.
3. Enter the scaling rate in the **Percentage** input box.  
You can also click the up/down arrows to select the scaling rate.
4. Select the **Size**, **Source**, and **Type** in **Paper Options**.
5. Click **OK** or **Print** until you exit the **Print** window.

## Fitting your document to a selected paper size

This feature allows you to scale your print job to any selected paper size regardless of the document size. This can be useful when you want to check fine details on a small document.

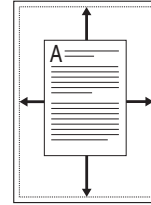

1. To change the print settings from your software application, access **Printing Preferences**. (See "Opening printing preferences" on page 34.)
2. Click the **Paper** tab.
3. Select the paper size you want from the **Fit to Page**.
4. Select the **Size**, **Source**, and **Type** in **Paper Options**.
5. Click **OK** or **Print** until you exit the **Print** window.

## Using watermarks

The watermark option allows you to print text over an existing document. For example, you use it when you want to have large gray letters reading "DRAFT" or "CONFIDENTIAL" printed diagonally across the first page or all pages of a document.

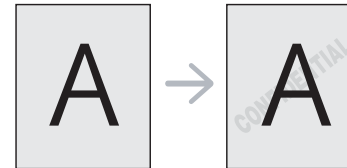

There are several predefined watermarks that come with the machine. They can be modified, or you can add new ones to the list.

### Using an existing watermark

1. To change the print settings from your software application, access **Printing Preferences**. (See "Opening printing preferences" on page 34.)
2. Click the **Advanced** tab, and select the desired watermark from the **Watermark** drop-down list. You will see the selected watermark in the preview image.
3. Click **OK** or **Print** until you exit the print window.

### Creating a watermark

1. To change the print settings from your software application, access **Printing Preferences**. (See "Opening printing preferences" on page 34.)
2. From the **Advanced** tab, select **Edit** from the **Watermark** drop-down list. The **Edit Watermarks** window appears.
3. Enter a text message in the **Watermark Message** box. You can enter up to 256 characters. The message displays in the preview window.  
When the **First Page Only** box is checked, the watermark prints on the first page only.
4. Select watermark options.  
You can select the font name, style, size, and shade from the **Font Attributes** section, as well as set the angle of the watermark from the **Message Angle** section.
5. Click **Add** to add a new watermark to the **Current Watermarks** list.



6. When you have finished, click **OK** or **Print** until you exit the **Print** window.

To stop printing the watermark, select **None** from the **Watermark** drop-down list.

### Editing a watermark

1. To change the print settings from your software application, access **Printing Preferences**. (See "Opening printing preferences" on page 34.)
2. Click the **Advanced** tab, select **Edit** from the **Watermark** drop-down list. The **Edit Watermarks** window appears.
3. Select the watermark you want to edit from the **Current Watermarks** list and change the watermark message and options.
4. Click **Update** to save the changes.
5. Click **OK** or **Print** until you exit the **Print** window.

### Deleting a watermark

1. To change the print settings from your software application, access **Printing Preferences**. (See "Opening printing preferences" on page 34.)
2. Click the **Advanced** tab, select **Edit** from the **Watermark** drop-down list. The **Edit Watermarks** window appears.
3. Select the watermark you want to delete from the **Current Watermarks** list and click **Delete**.
4. Click **OK** or **Print** until you exit the **Print** window.

### Using overlays

An overlay is content you store on your hard disk drive that can be superimposed over any document you print. An overlay is often used to take the place of letterhead paper. Rather than using preprinted letterhead, you can create an overlay containing exactly the same information that is currently on your letterhead. To print a letter with your company's letterhead, you do not need to load preprinted letterhead paper in the machine, instead you can just print the letterhead overlay on your document.

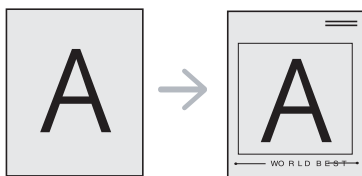

### Creating a new overlay

To use a page overlay, you must create a new page overlay file containing your content.

1. Create or open a document containing the content you want to use in a new page overlay. Position the items exactly where you want them to appear when they are added to the original.
2. To save the document as an overlay, access **Printing Preferences**. (See "Opening printing preferences" on page 34.)
3. Click the **Advanced** tab, and select **Edit** from the **Text** drop-down list. The **Edit Overlay** window appears.
4. In the **Edit Overlay** window, click **Create**.
5. In the **Save As** window, type a name of up to eight characters in the **File name** box. Select the destination path, if necessary. (The default is C:\Formover.)
6. Click **Save**. The name appears on the **Overlay List**.
7. Click **OK** or **Print** until you exit the **Print** window.

8. The file is not printed. Instead, it is stored on your computer hard disk drive.

 The overlay document size must match same as the document you print. Do not create an overlay with a watermark.

### Using an overlay

After an overlay has been created, it is ready to be printed with your document. To print an overlay on your document:

1. Create or open the document you want to print.
2. To change the print settings from your software application, access **Printing Preferences**. (See "Opening printing preferences" on page 34.)
3. Click the **Advanced** tab.
4. Select the desired overlay from the **Text** drop-down list.
5. If the overlay file you want does not appear in the **Text** drop-down list, select **Edit** from the list and click **Load**. Select the overlay file you want to use.

If you have stored the overlay file you want to use in an external source, you can also load the file when you access the **Open** window.

After you select the file, click **Open**. The file appears in the **Overlay List** box and is available for printing. Select the overlay from the **Overlay List** box.

6. If necessary, check **Confirm Page Overlay When Printing** box. If this box is checked, a message window appears each time you submit a document for printing, asking you to confirm that you wish to print an overlay over your document.

If this box is not checked and an overlay has been selected, the overlay automatically prints with your document.

7. Click **OK** or **Print** until you exit the **Print** window. The selected overlay prints over your document.

 The resolution of the overlay document must match the resolution of the original print job.

### Deleting an overlay

You can delete page overlays that you no longer use.

1. In the **Printing Preferences** window, click the **Advanced** tab.
2. Select **Edit** in the **Overlay** drop down list.
3. Select the overlay you want to delete from the **Overlay List** box.
4. Click **Delete**.
5. When the confirmation message window appears, click **Yes**.
6. Click **OK** or **Print** until you exit the **Print** window.

### Print quality options

Use the following Graphics options to adjust the print quality for your specific printing needs.

1. To change the print settings from your software application, access **Printing Preferences**. (See "Opening printing preferences" on page 34.)
2. Click the **Graphics** tab.

 • The options you can select may vary depending on your printer model.  
• Refer to the help for each option's information provided from the **Printing Preferences**.

- **Font/Text:** Select **Darken Text** to print text darker than on a normal document. Use **All Text Black** to print solid black, regardless of the color it appears on the screen.

- **Graphic Controller: Fine Edge** allows you to emphasize edges of texts and fine lines for improving readability.
  - **Toner Save:** Selecting this option extends the life of your toner cartridge and reduces your cost per page without a significant reduction in print quality.
    - **Printer Setting:** If you select this option, this feature is determined by the setting you've made from the machine (For some models, you cannot change the setting from the machine. In this case, the default setting is Off).
    - **On:** Select this option to allow the printer to use less toner on each page.
    - **Off:** Select this option if you do not want to save toner when printing a document.
  - **Darkness:** The option adjusts the toner density on print outputs. The values are **Normal**, **Light**, and **Dark**.
3. Click **OK** or **Print** until you exit the **Print** window.

## Changing the default print settings

Most Windows applications will override settings you specify in the printer driver. Change all print settings available in the software application first, and change any remaining settings using the printer driver.

1. Click the Windows **Start** menu.
2. For Windows 2000, select **Settings > Printers**.
  - For Windows XP/2003, select **Printers and Faxes**.
  - For Windows 2008/Vista, select **Control Panel > Hardware and Sound > Printers**.
  - For Windows 7, select **Control Panel > Hardware and Sound > Devices and Printers**.
  - For Windows Server 2008 R2, select **Control Panel > Hardware > Devices and Printers**.
3. Right-click your machine.
4. For Windows XP/2003/2008/Vista, press **Printing Preferences**. For Windows 7 and Windows Server 2008 R2, from context menus, select the **Printing preferences**.

If **Printing preferences** item has a ► mark, you can select other printer drivers connected with the selected printer.

5. Change the settings on each tab.
6. Click **OK**.

If you want to change the settings for each print job, change it in **Printing Preferences**.

## Setting your machine as a default machine

1. Click the Windows **Start** menu.
2. For Windows 2000, select **Settings > Printers**.
  - For Windows XP/2003, select **Printers and Faxes**.
  - For Windows 2008/Vista, select **Control Panel > Hardware and Sound > Printers**.
  - For Windows 7, select **Control Panel > Hardware and Sound > Devices and Printers**.
  - For Windows Server 2008 R2, select **Control Panel > Hardware > Devices and Printers**.
3. Select your machine.
4. Right-click your machine and select **Set as Default Printer**.



For Windows 7 and Windows Server 2008 R2  
If **Set as default printer** item has a ► mark, you can select other printer drivers connected with the selected printer.

## Printing to a file (PRN)

You will sometimes need to save the print data as a file.  
To save a print job as a file:

1. Check the **Print to file** box at the **Print** window.

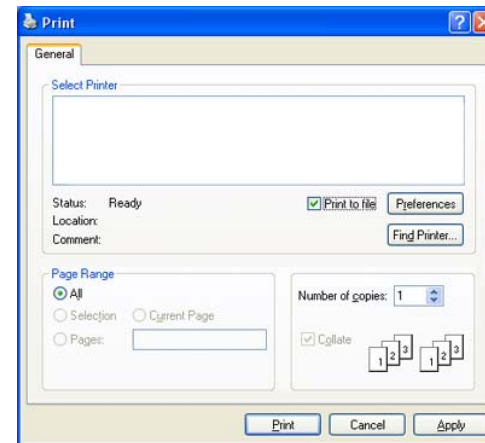

2. Click **Print**.
3. Type in the destination path and the file name, and then click **OK**. For example c:\Temp\file name.



If you type in only the file name, the file is automatically saved in **My Documents and Settings** or **Users**. The saved folder may differ depending on your operating system or the application you are using.

## Macintosh printing

This chapter explains how to print using a Macintosh. You need to set the print environment before printing.

- USB connected (See "Macintosh" on page 25.)

### Printing a document

When you print with a Macintosh, you need to check the printer driver setting in each application you use. Follow the steps below to print from a Macintosh:

1. Open an application and select the file you want to print.
2. Open the **File** menu and click **Page Setup (Document Setup** in some applications).

- Choose your paper size, orientation, scaling, other options, and make sure that your machine is selected. Click **OK**.

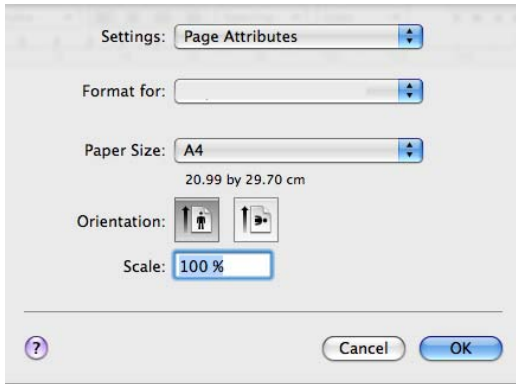

- Open the **File** menu and click **Print**.
- Choose the number of copies you want and indicate which pages you want to print.
- Click **Print**.

## Changing printer settings

You can use advanced printing features provided by your machine.

Open an application and select **Print** from the **File** menu. The machine name, which appears in the printer properties window may differ depending on the machine in use. Except for the name, the composition of the printer properties pane is similar to the following.

- The setting options may differ depending on models and Macintosh OS versions.
- The following panes may differ, depending on your operating system or the application you are using.

The following pane is the first pane you will see when you open the printer properties pane. Select other advanced features from the drop down list.

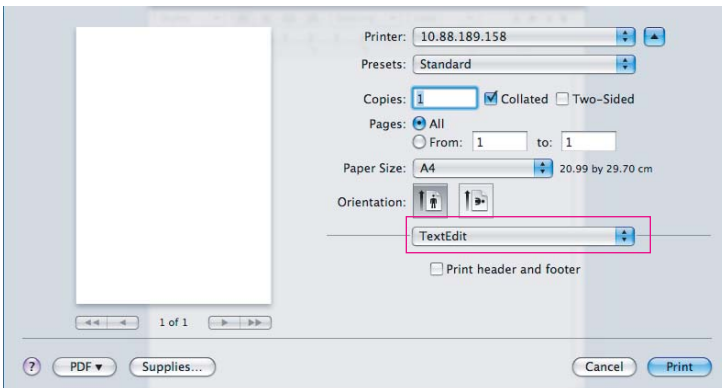

## Layout

The **Layout** dialog provides options to adjust how the document appears on the printed page. You can print multiple pages on one sheet of paper. Select **Layout** from the drop-down list under **Orientation** to access the following features.

- Pages per Sheet:** This option determines how many pages to be printed on one page. (See "Printing multiple pages on one sheet of paper" on page 39.)
- Layout Direction:** This option allows you to select the printing direction on a page similar to the examples on UI.
- Border:** This option allows you to print a border around each page

on the sheet.

- Reverse Page Orientation:** This option allows you to rotate paper 180 degrees.

## Graphics

The **Graphics** dialog provides options for selecting **Resolution**. Select **Graphics** from the drop-down list under **Orientation** to access the graphic features.

- Resolution (Quality):** This option allows you to select the printing resolution. The higher the setting, the sharper the clarity of printed characters and graphics. A higher setting will also increase the time it takes to print a document.
- Darkness:** This option allows you to enhance the darkness of the printouts. The available options are **Normal**, **Light**, and **Dark**.

## Printer Features

- Paper Type:** Set paper type to correspond to the paper loaded in the tray from which you want to print. This will let you get the best quality printout. If you load a different type of print material, select the corresponding paper type.

## Printer Settings

- Toner Save Mode:** Selecting this option extends the life of your toner cartridge and reduces your cost per page without a significant reduction in print quality.
  - Printer Setting:** If you select this option, this feature is determined by the setting you've made from the machine (For some models, you cannot change the setting from the machine. In this case, the default setting is Off).
  - On:** Select this option to allow the printer to use less toner on each page.
  - Off:** Set this option if you do not need to save toner when printing a document.
- Power Save:** When you will not be using the machine for a while, you can use this feature to save power. Select a value from the drop-down list in **Time Delay**.

## Printing multiple pages on one sheet of paper

You can print more than one page on a single sheet of paper. This feature provides a cost-effective way to print draft pages.

- Open an application, and select **Print** from the **File** menu.
- Select **Layout** from the drop-down list under **Orientation**. In the **Pages per Sheet** drop-down list, select the number of pages you want to print on one sheet of paper.

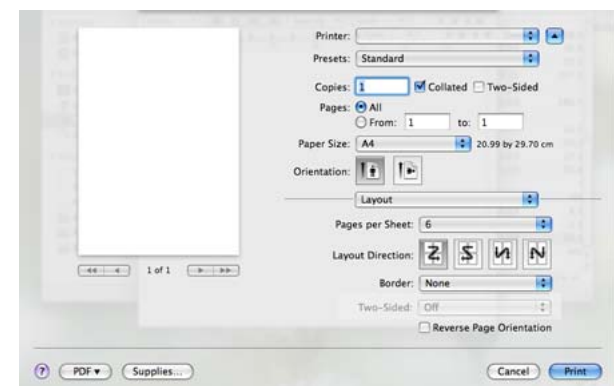

- Select the other options you want to use.

- Click **Print**, then the machine prints the selected the number of pages you want to print on one sheet of paper.

## Linux printing

### Printing from applications

There are several Linux applications that allow you to print using the Common UNIX Printing System (CUPS). You can print using any of these applications.

- Open an application, and select **Print** from the **File** menu.
- Select **Print** directly using LPR.
- From the LPR GUI window, select the model name of your machine from the printer list and click **Properties**.

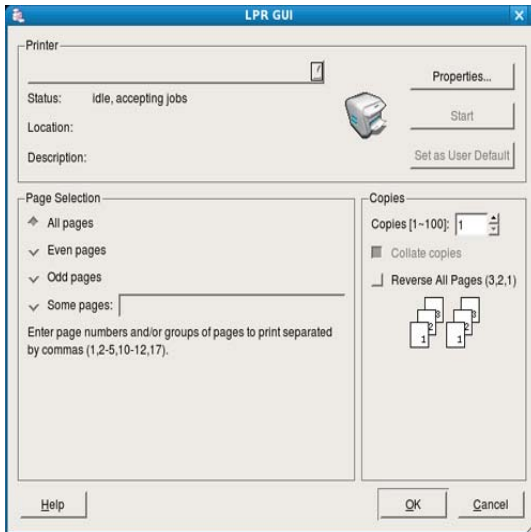

- Change the print job properties using the following four tabs displayed at the top of the window.

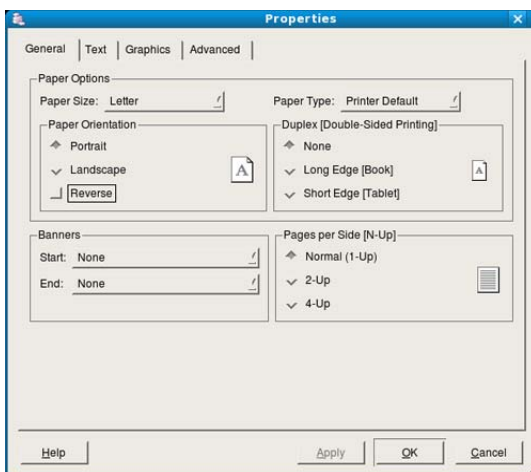

- General:** This option allows you to change the paper size, the paper type, and the orientation of the documents. It enables the duplex feature, adds start and end banners, and changes the number of pages per sheet.
- Text:** This option allows you to specify the page margins and set the text options, such as spacing or columns.
- Graphics:** This option allows you to set image options that are used

when printing images/files, such as color options, image size, or image position.

- Advanced:** This option allows you to set the print resolution, paper source and special print features.



If an option is grayed out, it means that the grayed out option is not supported by your machine.

- Click **Apply** to apply the changes and close the **Properties** window.
- Click **OK** in the **LPR GUI** window to start printing.
- The Printing window appears, allowing you to monitor the status of your print job.  
To abort the current job, click **Cancel**.

### Printing files

You can print many different types of files on your machine using the standard CUPS way, directly from the command line interface. The CUPS LPR utility allows you to do that. But the drivers package replaces the standard LPR tool by a much more user-friendly LPR GUI program.

To print any document file:

- Type `lpr <file_name>` from the Linux shell command line and press Enter. The **LPR GUI** window appears.  
When you type only `lpr` and press **Enter**, the **Select file(s) to print** window appears first. Just select any files you want to print and click **Open**.
- From the **LPR GUI** window, select your machine from the list, and change the print job properties.
- Click **OK** to start printing.

### Configuring printer properties

Using the **Printer Properties** window provided by the **Printers configuration**, you can change the various properties for your printer.

- Open the **Unified Driver Configurator**.  
If necessary, switch to **Printers configuration**.
- Select your machine from the available printers list and click **Properties**.
- The **Printer Properties** window opens.

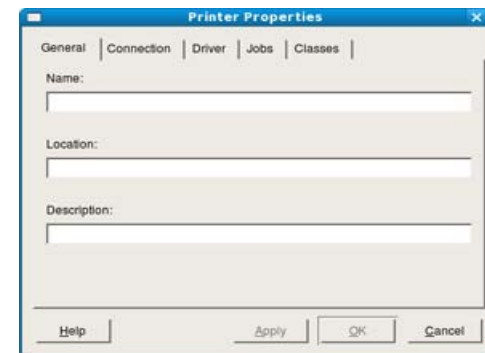

The following five tabs display at the top of the window:

- General:** This option allows you to change the printer location and name. The name entered in this tab displays on the printer list in **Printers configuration**.
- Connection:** This option allows you to view or select another port. If you change the machine port from USB to parallel or vice versa while in use, you must re-configure the machine port in this tab.
- Driver:** Allows you to view or select another printer driver. By clicking **Options**, you can set the default device options.
- Jobs:** This option shows the list of print jobs. Click **Cancel job** to

cancel the selected job and select the **Show completed jobs** check box to see previous jobs on the job list.

- **Classes:** This option shows the class that your machine is in. Click **Add to Class** to add your machine to a specific class or click **Remove from Class** to remove the machine from the selected class.
4. Click **OK** to apply the changes and close the **Printer Properties** window.



# management tools

This chapter introduces management tools provided to help you make full use of your machine.

## This chapter includes:

- Introducing useful management tools
- Using Samsung Easy Printer Manager (Windows only)
- Using Samsung Printer Status (Windows only)

## Introducing useful management tools

The programs below help you to use your machine conveniently.

- "Using Samsung Easy Printer Manager (Windows only)" on page 42
- "Using Samsung Printer Status (Windows only)" on page 43
- "Using the Smart Panel program (Macintosh and Linux only)" on page 43.
- "Using the Unified Linux Driver Configurator" on page 44.

## Using Samsung Easy Printer Manager (Windows only)

Samsung Easy Printer Manager is a Windows-based application that combines Samsung machine settings into one location. Samsung Easy Printer Manager combines device settings as well as printing environments, settings/actions and launching. All of these features provide a gateway to conveniently use your Samsung machine.

- Internet Explorer 6.0 or higher is the minimum requirement for Samsung Easy Printer Manager.

- Using the Smart Panel program (Macintosh and Linux only)
- Using the Unified Linux Driver Configurator



## Understanding Samsung Easy Printer Manager

To open the program:

Select **Start > Programs** or **All Programs > Samsung Printers > Samsung Easy Printer Manager > Samsung Easy Printer Manager**.

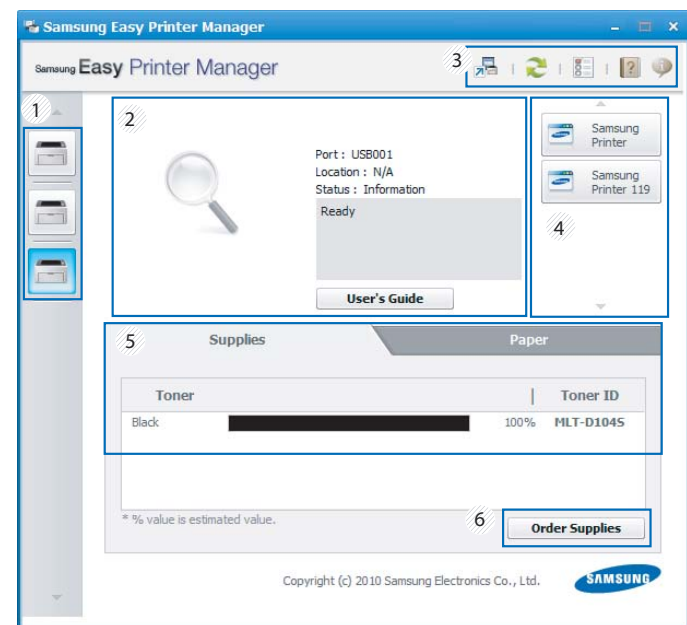
The Easy Printer Manager interface is comprised of various basic sections as described in the table that follows:



1	<b>Printer List</b>	The printer list is displayed as icons.
2	<b>Printer Information</b>	This area gives you general information about your machine. You can check information, such as the machine's model name, IP address (or Port name), and machine status.   <b>User's Guide button:</b> This button opens <b>Troubleshooting Guide</b> when an error occurs. You can directly open the necessary section in the user's guide.
3	<b>Application information</b>	Includes links for changing to the advanced settings, preference, help, and about.   The  button is used to change the user interface to the advanced settings user interface.
4	<b>Quick links</b>	Displays <b>Quick links</b> to machine specific functions. This section also includes links to applications in the advanced settings.
5	<b>Contents Area</b>	Displays information about the selected machine, remaining toner level, and paper. The information will vary based on the machine selected. Some machines do not have this feature.
6	<b>Order Supplies</b>	Click on the <b>Order</b> button from the supply ordering window. You can order replacement toner cartridge(s) from online.

 Click the **Help** (?) button from the upper-right corner of the window and click on any option you want to know about.

### Using Easy Capture Manager

You can use the Easy Capture Manager program after installing Samsung Easy Printer Manager. Press **Print Screen** key on your keyboard. The Easy Capture Manager program appears. It helps you to gather screen fragments and to pack them in few pages instead of printing each fragment on a separate page, to print only you want to print and thus saving paper and toner.

### Using Samsung Printer Status (Windows only)

The Samsung Printer Status is a program that monitors and informs you of the machine status.



-  The Samsung Printer Status window and its contents shown in this user's guide may differ depending on the machine or operating system in use.
- Check the operating system(s) that are compatible with your machine (see Basic guide).

### Samsung Printer Status overview

If an error occurs while operating, you can check the error from the Samsung Printer Status. Samsung Printer Status is installed automatically when you install the machine software.

You can also launch Samsung Printer Status manually. Go to the **Printing Preferences**, click the **Basic** tab > **Printer Status** button.

These icons appear on the Windows task bar:

Icon	Mean	Description
	Normal	The machine is in ready mode and experiencing no errors or warnings.
	Warning	The machine is in a state where an error might occur in the future. For example, it might be in toner low status, which may lead to toner empty status.
	Error	The machine has at least one error.

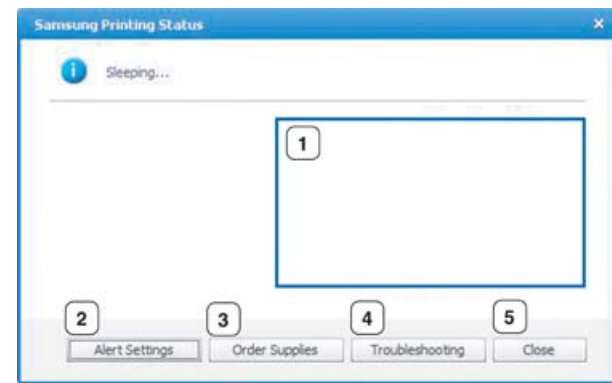

1	<b>Toner Level</b>	You can view the level of toner remaining in each toner cartridge. The machine and the number of toner cartridge(s) shown in the above window may differ depending on the machine in use. Some machines do not have this feature.
2	<b>Alert Settings</b>	Select the settings you want from the options window.
3	<b>Order Supplies</b>	You can order replacement toner cartridge(s) from online.
4	<b>Troubleshooting</b>	You can directly open the troubleshooting section in the user's guide.
5	<b>Close</b>	Close the window.

### Using the Smart Panel program (Macintosh and Linux only)

Smart Panel is a program that monitors and informs you of the machine status, and allows you to customize the machine's driver settings. For Macintosh, Smart Panel is installed automatically when you install the machine software. For Linux, you can download the Smart Panel from the Samsung website (See "Installing the SmartPanel" on page 26).

 To use this program, your computer has to meet the following system requirements:

- Mac OS X 10.3 or higher. Check that your computers CPU, RAM, and HDD meet or exceed spec. (See "System requirements" on page 23.)
- Linux. Check that your computers CPU, RAM, and HDD meet or exceed spec.  
e. (See "System requirements" on page 23.)

If you need to know the exact model number of your machine, you can check the supplied software CD.

## Understanding Smart Panel

If an error occurs while printing, you can check the error from the Smart Panel.

You can also launch Smart Panel manually. Double-click the Smart Panel icon on the Notification Area (in Linux).

Linux		Click this icon in Linux.
-------	---	---------------------------

- If you have already installed more than one Samsung machine, first select the correct machine model you want in order to access the corresponding Smart Panel.  
Right-click (in Linux) the Smart Panel icon and select your machine.
- The Smart Panel window and its contents shown in this user's guide may differ depending on the machine or operating system in use.

In case of Mac OS 10.3

1. Click '**Print & Fax**' in System Preferences
2. Click '**Set up Printers...**'.
3. Select printer in list and double click it.
4. Click '**Utility**'.

In case of Mac OS 10.4

1. Click '**Print & Fax**' in System Preferences
2. Select printer in list and click '**Printer Queue...**'.
3. Click '**Utility**'.

In case of Mac OS 10.5

1. Click '**Print & Fax**' in System Preferences
2. Select printer in list and click '**Open Printer Queue...**'.
3. Click '**Utility**'.

In case of Mac OS 10.6

1. Click '**Print & Fax**' in System Preferences
2. Select printer in list and click '**Open Printer Queue...**'.
3. Click '**Printer Setup**'.
4. Click '**Utility**' tab.
5. Click '**Open Printer Utility**'.

The Smart Panel program displays the current status of the machine, the level of toner remaining in the toner cartridge(s), and various other types of information. You can also change settings.

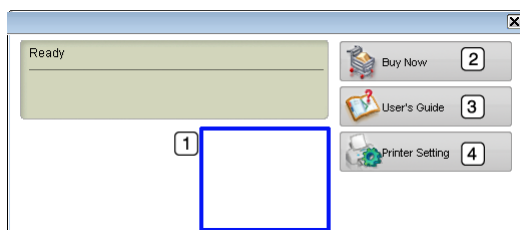

1	<b>Toner Level</b>	View the level of toner remaining in the toner cartridge(s). The machine and the number of toner cartridge(s) shown in the above window may differ depending on the machine in use. Some machines do not have this feature.
2	<b>Buy Now</b>	Order replacement toner cartridge(s) online.
3	<b>User's Guide</b>	View the User's Guide.  This button changes to <b>Troubleshooting Guide</b> when error occurs. You can directly open the troubleshooting section in the user's guide.

## Opening the Troubleshooting Guide

Find solutions for problems by using the **Troubleshooting Guide**.

Right-click (in Linux) the Smart Panel icon and select **Troubleshooting Guide**.

## Changing the Smart Panel Program Settings

Right-click (in Linux) the Smart Panel icon and select **Options**. Select the settings you want from the **Options** window.

## Using the Unified Linux Driver Configurator

The Unified Driver Configurator is a tool primarily intended for configuring machine devices. You need to install Unified Linux Driver to use Unified Driver Configurator (See "Installing the Unified Linux Driver" on page 25).

After the driver is installed on your Linux system, the Unified Driver Configurator icon will automatically be created on your desktop.

## Opening the Unified Driver Configurator

1. Double-click the **Unified Driver Configurator** on the desktop.  
You can also click the **Startup** Menu icon and select **Samsung Unified Driver > Unified Driver Configurator**.
2. Click each button on the left to switch to the corresponding configuration window.

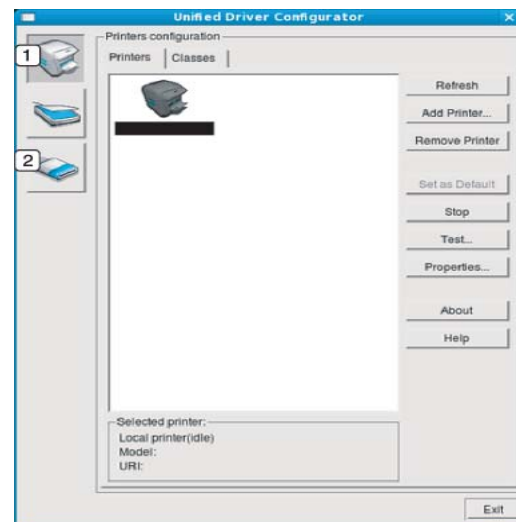

 To use the on screen help, click **Help**.



- After changing the configurations, click **Exit** to close the Unified Driver Configurator.

## Printers configuration window

Printers configuration has the two tabs: **Printers** and **Classes**.

### Printers tab

View the current system's printer configuration by clicking on the machine icon button on the left side of the Unified Driver Configurator window.

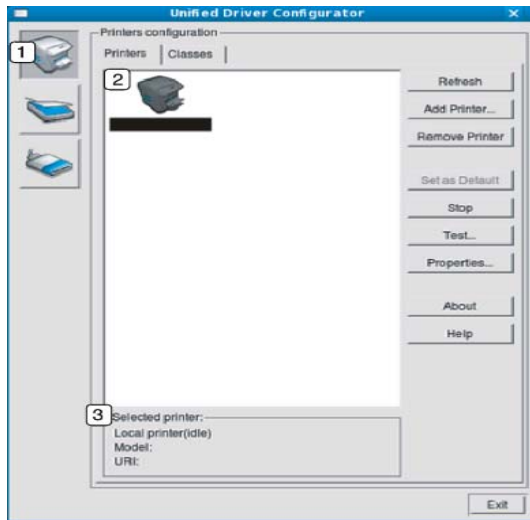

- |   |   |
|---|---|
| 1 | Switches to <b>Printers configuration</b> .           |
| 2 | Shows all of the installed machine.                   |
| 3 | Shows the status, model name and URI of your machine. |

The printer control buttons are, as follows:

- Refresh:** Renews the available machines list.
- Add Printer:** Allows you to add a new machines.
- Remove Printer:** Removes the selected machine.
- Set as Default:** Sets the current selected machine as a default machine.
- Stop/Start:** Stops/starts the machine.
- Test:** Allows you to print a test page to ensure the machine is working properly.
- Properties:** Allows you to view and change the printer properties.

## Classes tab

The Classes tab shows a list of available machine classes.

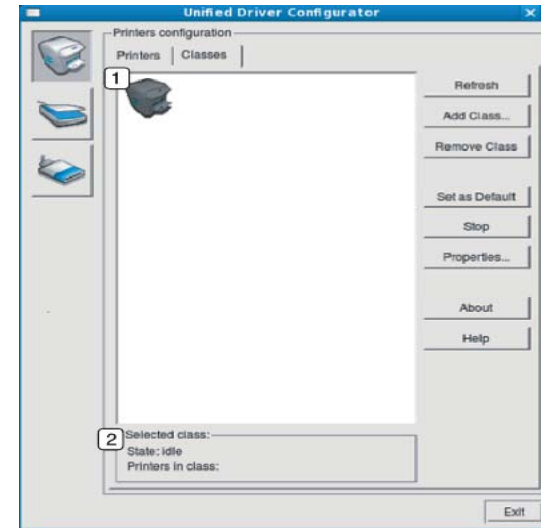

- |   |   |
|---|---|
| 1 | Shows all of the machine classes.   |
| 2 | Shows the status of the class and the number of machines in the class. <ul style="list-style-type: none"> <li><b>Refresh:</b> Renews the classes list.</li> <li><b>Add Class:</b> Allows you to add a new machine class.</li> <li><b>Remove Class:</b> Removes the selected machine class.</li> </ul> |

## Ports configuration

In this window, you can view the list of available ports, check the status of each port, and release a port that is stalled in a busy state when its owner has terminated the job for any reason.

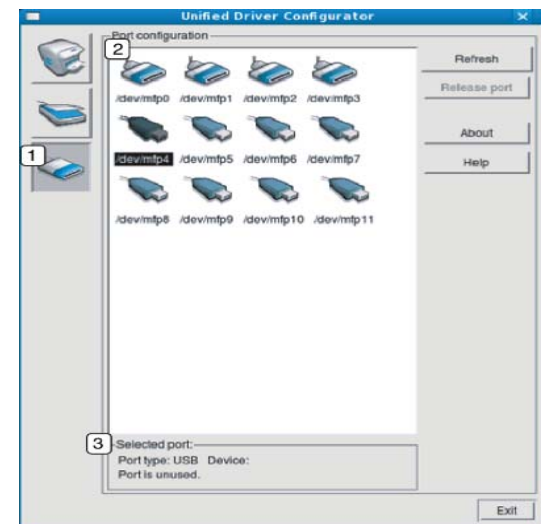

- |   |  |
|---|--|
| 1 | Switches to <b>Ports configuration</b> .                       |
| 2 | Shows all of the available ports.                              |
| 3 | Shows the port type, device connected to the port, and status. |

- **Refresh:** Renews the available ports list.
- **Release port:** Releases the selected port.

# maintenance

This chapter provides information about maintaining your machine and the toner cartridge.

## This chapter includes:

- Printing a machine report
- Cleaning a machine

## Printing a machine report

You can print a configuration page to view current printer settings, or to help troubleshoot printer problems.

(See "Printing a configuration sheet" on page 22.)

## Cleaning a machine

If printing quality problems occur or if you use your machine in a dusty environment, you need to clean your machine regularly to keep the the most optimum print quality.

- ⚠ • Cleaning the outside of the machine with cleaning materials containing large amounts of alcohol, solvent, or other strong substances can discolor or distort the cabinet.
- If your machine or the surrounding area is contaminated with toner, we recommend that you use a cloth or tissue dampened with water to clean it. If you use a vacuum cleaner, toner blows in the air and might be harmful if inhaled.

### Cleaning the outside

Clean the machine cabinet with a soft, lint-free cloth. Dampen the cloth slightly with water, but be careful not to let any water drip onto or into the machine.

### Cleaning the inside

During the printing process, paper dust, toner, and dust particles in the air can accumulate inside the machine. This buildup can cause print quality problems, such as toner specks or smearing. Cleaning the inside of the machine clears and reduces these problems.

- Storing the toner cartridge
- Tips for moving & storing your machine

1. Turn the machine off and unplug the power cord. Wait for the machine to cool down.
2. Open the top cover and pull the toner cartridge out. Set it on a clean flat surface.

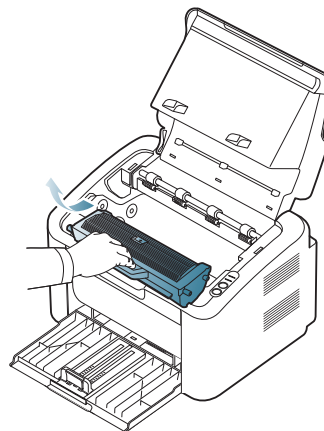

- ⚠ • To prevent damage to the toner cartridge, do not expose it to light for more than few minutes. Cover it with a piece of paper, if necessary.
  - Do not touch the green surface of the drum located in the toner cartridge or imaging unit. Use the handle on the cartridge to avoid touching this area.
3. With a dry, lint-free cloth, wipe away any dust and spilled toner from the toner cartridge area.

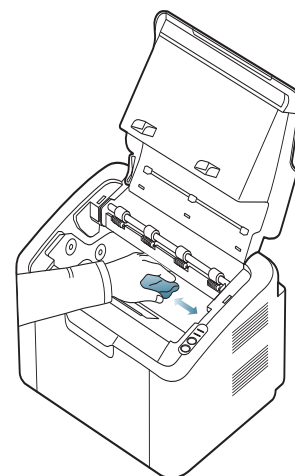

- ⚠ While cleaning the inside of the machine, be careful not to damage the transfer roller or any other inside parts. Do not use solvents

such as benzene or thinner to clean. Printing quality problems can occur and cause damage to the machine.

4. Reinsert the toner cartridge and close the top cover.
5. Plug in the power cord and turn the machine on.

## Storing the toner cartridge

---

Toner cartridges contain components that are sensitive to light, temperature, and humidity. Samsung suggests users follow the recommendations below to ensure the optimum performance, highest quality, and longest life from your new Samsung toner cartridge.

Store this cartridge in the same environment as the printer it will be used in; this should be in controlled office temperature and humidity conditions. The toner cartridge should remain in its original, unopened package until installation – If original packaging is not available, cover the top opening of the cartridge with paper and store it in a dark cabinet.

Opening the cartridge package prior to use dramatically shortens its useful shelf and operating life. Do not store on the floor. If the toner cartridge is removed from the printer, always store the cartridge according to the following guidelines:

- Inside the protective bag from the original package.
- Store lying flat (not standing on end) with the same side facing up as if it was installed in the machine.
- Do not store consumable in any of the following conditions:
  - Temperature greater than 40°C (104°F).
  - Humidity range less than 20% and not greater than 80%.
  - An environment with extreme changes in humidity or temperature.
  - Direct sunlight or room light.
  - Dusty places.
  - A car for a long period of time.
  - An environment where corrosive gases are present.
  - An environment with salty air.

## Handling instructions

- Do not touch the surface of the photoconductive drum in the cartridge.
- Do not expose the cartridge to unnecessary vibrations or shock.
- Never manually rotate the drum, especially in the reverse direction; this can cause internal damage and toner spillage.

## Use of non-Samsung and refilled toner cartridge

Samsung Electronics does not recommend or approve the use of non-Samsung brand toner cartridges in your printer including generic, store brand, refilled, or remanufactured toner cartridges.



Samsung's printer warranty does not cover damage to the machine caused by the use of a refilled, remanufactured, or non-Samsung brand toner cartridge.

## Estimated cartridge life

Estimated cartridge life (the life of the toner cartridge yield) depends on the amount of toner that print jobs require. The actual print yield may vary depending on the print density of the pages you print on, operating environment, printing interval, media type, and/or media size. For example, if you print a lot of graphics, the consumption of the toner is high and you may need to change the cartridge more often.

## Tips for moving & storing your machine

---

When moving the machine, do not tilt or turn it upside down. Otherwise, the inside of the machine may be contaminated by toner, which can cause damage to the machine or reduce print quality.

# troubleshooting

This chapter gives helpful information for what to do if you encounter an error.

## This chapter includes:

- Redistributing toner
- Tips for avoiding paper jams

## Redistributing toner

When the toner cartridge is near the end of its life:

- White streaks or light printing occurs.
- The  LED blinks red.

If this happens, you can temporarily improve print quality by redistributing the remaining toner in the cartridge. In some cases, white streaks or light printing will still occur even after you have redistributed the toner.

1. Open the top cover.

 When you open the top cover, make sure that the output tray is closed.

2. Pull the toner cartridge out.

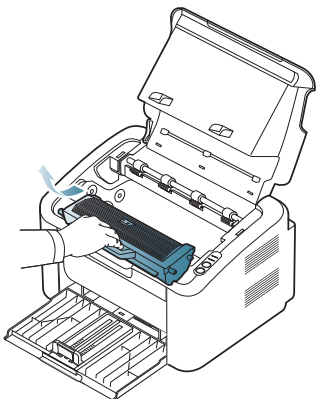

3. Thoroughly roll the cartridge five or six times to distribute the toner evenly inside the cartridge.

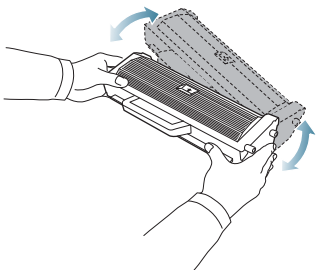

 If toner gets on your clothing, wipe it off with a dry cloth and wash clothing in cold water. Hot water sets toner into fabric.

 Do not touch the drum in the the toner cartridge or imaging unit. Use the handle on the cartridge to avoid touching this area.

4. Hold the toner cartridge by the handle and slowly insert the cartridge into the opening in the machine.

- Clearing paper jams
- Solving other problems

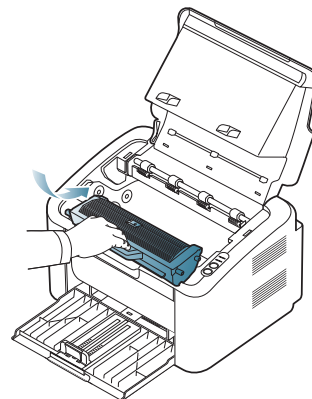

The tabs on the sides of the cartridge and corresponding grooves within the machine will guide the cartridge into the correct position until it locks into place completely.



5. Close the top cover. Ensure that the cover is securely closed.

## Tips for avoiding paper jams

By selecting the correct media types, most paper jams can be avoided. When a paper jam occurs, refer to the guidelines below:

- Ensure that the adjustable guides are positioned correctly. (See "Loading paper in the tray" on page 29.)
- Do not overload the tray. Ensure that the paper level is below the paper capacity mark on the inside of the tray.
- Do not remove paper from the tray while your machine is printing.
- Flex, fan, and straighten paper before loading.
- Do not use creased, damp, or highly curled paper.
- Do not mix paper types in a tray.
- Use only recommended print media.
- Ensure that the recommended side of the print media is facing the right side. (See "Loading paper in the tray" on page 29.)
- If duplexing, print one sheet at a time using the . (See "Printing on both sides of the paper (Manual)" on page 35.)
- If you are printing on a special paper, print one sheet at a time using the . (See "Manual feeding in the tray" on page 29.)

## Clearing paper jams

If a paper jam occurs, the  LED on the control panel lights orange. Find and remove the jammed paper.

To resume printing after clearing paper jams, you must open and close the top cover.

 To avoid tearing the paper, pull the jammed paper out slowly and carefully. Follow the instructions in the following sections to clear the jam.

## In tray

 Click this link to open an animation about clearing a jam.

1. If the output tray is opened, close the output tray first.
2. Open and close the top cover. The jammed paper is automatically ejected from the machine. Make sure to open the output tray before paper ejects from the machine.  
If the paper does not eject, go to the next step.
3. Remove the jammed paper by gently pulling it straight out.

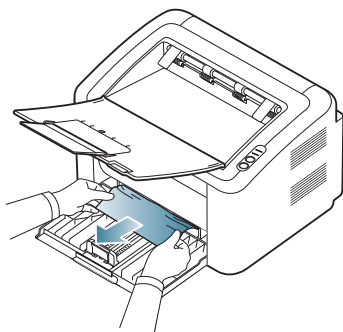

If the paper does not move when you pull, or if you do not see the paper in this area, check inside the machine. (See "Inside the machine" on page 50.)

## Inside the machine

 Click this link to open an animation about clearing a jam.

 The fuser area is hot. Be careful when removing paper from this area to prevent getting your fingers burnt.

1. If the output tray is opened, close the output tray first.
2. Open and close the top cover. The jammed paper is automatically ejected from the machine. Make sure to open the output tray before paper ejects from the machine.  
If the paper does not eject, go to the next step.
3. Close the output tray and open the top cover.
4. Open the fuser unit cover.

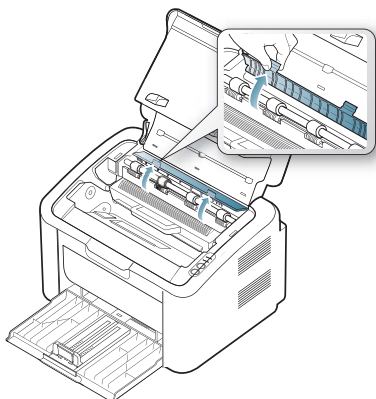

5. Remove the jammed paper by gently pulling it straight out.

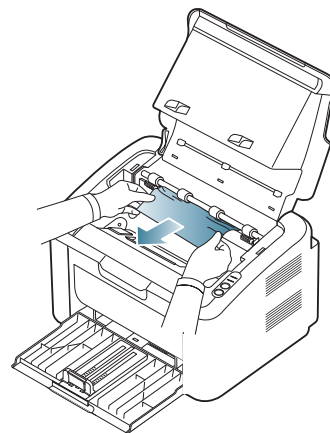

If you do not see the jammed paper, go to the next step.

6. Pull the toner cartridge out.

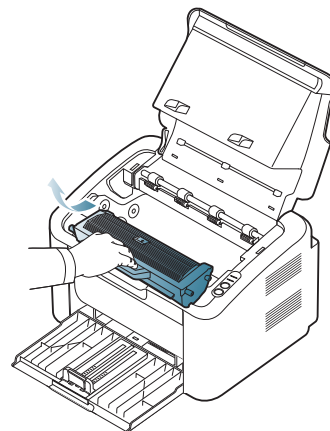

7. Remove the jammed paper by gently pulling it straight out.

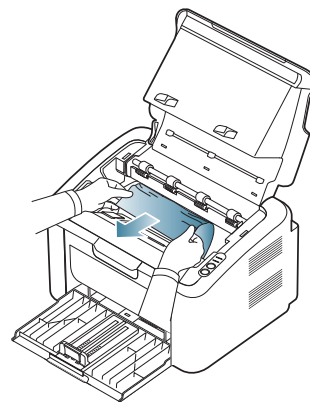

8. Insert the toner cartridge back into the machine.

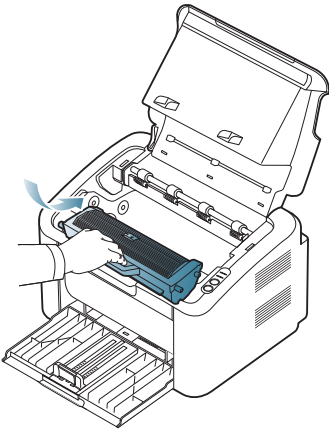

9. Close the fuser unit cover.

10. Close the top cover and open the output tray. Printing automatically resumes.

## Solving other problems

The following chart lists some trouble conditions that may occur and the recommended solutions. Follow the suggested solutions until the problem is corrected. If the problem persists, contact a service representative.

Other problems include:

- See "Power problems" on page 51.
- See "Paper feeding problems" on page 52.
- See "Printing problems" on page 52.
- See "Printing quality problems" on page 54.
- See "Common Windows problems" on page 56.
- See "Common Linux problems" on page 56.
- See "Common Macintosh problems" on page 57.

## Power problems

 Click this link to open an animation about solving power problems.

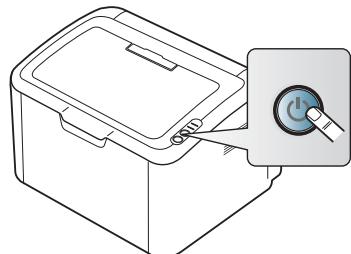
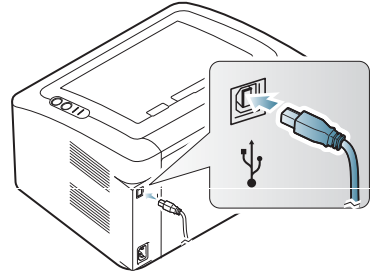
Condition	Suggested solutions
<b>The machine is not receiving power, or the connection cable between the computer and the machine is not connected properly.</b>	<ul style="list-style-type: none"><li>• Plug in the power cord and press  (power) on the control panel.</li></ul>  <ul style="list-style-type: none"><li>• Disconnect the machine cable and reconnect it.</li></ul> 



## Paper feeding problems

Condition	Suggested solutions
<b>Paper jams during printing.</b>	Clear the paper jam. (See "Clearing paper jams" on page 49.)
<b>Paper sticks together.</b>	<ul style="list-style-type: none"> <li>Check the maximum paper capacity of the tray. (See "Print media specifications" on page 62.)</li> <li>Make sure that you are using the correct type of paper. (See "Print media specifications" on page 62.)</li> <li>Remove paper from the tray and flex or fan the paper.</li> <li>Humid conditions may cause some paper to stick together, replace with a new stack.</li> </ul>
<b>Multiple sheets of paper do not feed.</b>	Different types of paper may be stacked in the tray. Load paper of only one type, size, and weight.
<b>Paper does not feed into the machine.</b>	<ul style="list-style-type: none"> <li>Remove any obstructions from inside the machine.</li> <li>Paper has not been loaded correctly. Remove paper from the tray and reload it correctly.</li> <li>There is too much paper in the tray. Remove excess paper from the tray.</li> <li>The paper is too thick. Use only paper that meets the specifications required by the machine. (See "Print media specifications" on page 62.)</li> </ul>
<b>The paper keeps jamming.</b>	<ul style="list-style-type: none"> <li>There is too much paper in the tray. Remove excess paper from the tray. If you are printing on special materials, use the manual feeder.</li> <li>An incorrect type of paper is being used. Use only paper that meets the specifications required by the machine. (See "Print media specifications" on page 62.)</li> <li>There may be debris inside the machine. Open the top cover and remove any debris.</li> </ul>
<b>Transparencies stick together in the paper exit.</b>	Use only transparencies specifically designed for laser printers. Remove each transparency as it exits from the machine.
<b>Envelopes skew or fail to feed correctly.</b>	Ensure that the paper guides are against both sides of the envelopes.

## Printing problems

Condition	Possible cause	Suggested solutions
<b>The machine does not print.</b>	The machine is not receiving power.	Check the power cord connections.
	The machine is not selected as the default machine.	Select your machine as your default machine in your Windows.
	Check the machine for the following: <ul style="list-style-type: none"> <li>The top cover is not closed. Close the top cover.</li> <li>Paper is jammed. Clear the paper jam. (See "Clearing paper jams" on page 49.)</li> <li>No paper is loaded. Load paper. (See "Loading paper in the tray" on page 29.)</li> <li>The toner cartridge is not installed. Install the toner cartridge.</li> </ul> If a system error occurs, contact a service representative.	
	The connection cable between the computer and the machine is not connected properly.	Disconnect the machine cable and reconnect it.
	The connection cable between the computer and the machine is defective.	If possible, attach the cable to another computer that is working properly and print a job. You can also try using a different machine cable.
	The port setting is incorrect.	Check the Windows printer settings to make sure that the print job is sent to the correct port. If the computer has more than one port, make sure that the machine is attached to the correct one.
	The machine may be configured incorrectly.	Check the <b>Printing Preferences</b> to ensure that all of the print settings are correct. (See "Opening printing preferences" on page 34.)
	The printer driver may be incorrectly installed.	Repair the machine software (See "Installing USB connected machine's driver" on page 23).
	The machine is malfunctioning.	<ul style="list-style-type: none"> <li>Check the LEDs on the control panel to see if the machine is indicating a system error. If the error cannot be cleared, contact a service representative.</li> <li>Checking an error message is also possible from the Printer Status or the Smart Panel on your computer.</li> </ul>



Condition	Possible cause	Suggested solutions
<b>The machine does not print.</b>	The document size is so big that the hard disk space of the computer is insufficient to access the print job.	Allocate more hard disk space on your computer for spooling, and try printing.
<b>The machine selects print materials from the wrong paper source.</b>	The paper option that was selected in the <b>Printing Preferences</b> may be incorrect.	For many software applications, the paper source selection is found under the Paper tab within the <b>Printing Preferences</b> . Select the correct paper source. See the printer driver help screen. (See "Opening printing preferences" on page 34.)
<b>A print job is extremely slow.</b>	The job may be very complex.	Reduce the complexity of the page or try adjusting the print quality settings.
<b>Half the page is blank.</b>	The page orientation setting may be incorrect.	Change the page orientation in your application. See the printer driver help screen.
	The paper size and the paper size settings do not match.	Ensure that the paper size in the printer driver settings matches the paper in the tray. Or, ensure that the paper size in the printer driver settings matches the paper selection in the software application settings you use.
<b>The machine prints, but the text is wrong, garbled, or incomplete.</b>	The machine cable is loose or defective.	Disconnect the machine cable and reconnect. Try a print job that you have already printed successfully. If possible, attach the cable and the machine to another computer that you know works and try a print job. Finally, try a new machine cable.
	The wrong printer driver was selected.	Check the application's printer selection menu to ensure that your machine is selected.
	The software application is malfunctioning.	Try printing a job from another application.
	The operating system is malfunctioning.	Exit Windows and reboot the computer. Turn the machine off and back on again.

Condition	Possible cause	Suggested solutions
<b>Pages print, but they are blank.</b>	The toner cartridge is defective or out of toner.	Redistribute the toner, if necessary. If necessary, replace the toner cartridge.
	The file may have blank pages.	Check the file to ensure that it does not contain blank pages.
	Some parts, such as the controller or the board, may be defective.	Contact a service representative.
<b>The machine does not print PDF files correctly. Some graphics, text, or illustrations are missing.</b>	Incompatibility between the PDF file and the Acrobat products.	Printing the PDF file as an image may enable the file to print. Turn on <b>Print As Image</b> from the Acrobat printing options.  It will take longer to print when you print a PDF file as an image.
<b>The print quality of photos is not good. Images are not clear.</b>	The resolution of the photo is very low.	Reduce the photo size. If you increase the photo size in the software application, the resolution will be reduced.
<b>Before printing, the machine emits vapor near the output tray.</b>	Using damp paper can cause vapor during printing.	This is not a problem. Just keep printing.
<b>The machine does not print special- sized paper, such as billing paper.</b>	Paper size and paper size setting do not match.	Set the correct paper size in the <b>Edit...</b> in the <b>Paper</b> tab in the <b>Printing Preferences</b> . (See "Opening printing preferences" on page 34.)

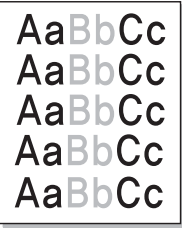
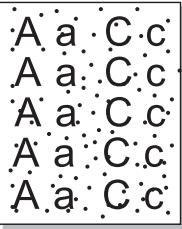
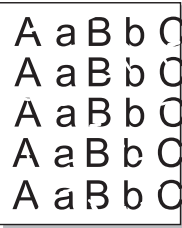

## Printing quality problems

If the inside of the machine is dirty or paper has been loaded improperly, there might be a reduction in print quality. See the table below to clear the problem.

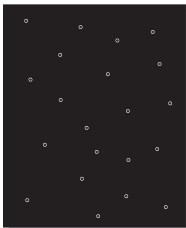
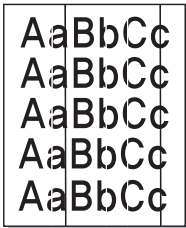
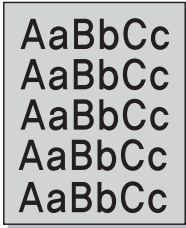
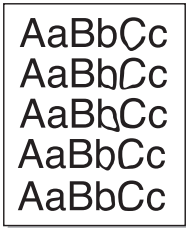
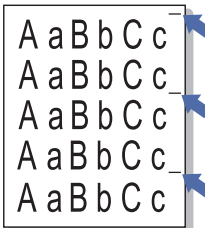
Condition	Suggested Solutions
<p><b>Light or faded print</b></p> 	<ul style="list-style-type: none"> <li>If a vertical white streak or faded area appears on the page, the toner supply is low. You may be able to temporarily extend the toner cartridge life. (See "Redistributing toner" on page 49.) If this does not improve the print quality, install a new toner cartridge.</li> <li>The paper may not meet paper specification; for example, the paper may be too moist or rough. (See "Print media specifications" on page 62.)</li> <li>If the entire page is light, the print resolution setting is too low or the toner save mode is on. Adjust the print resolution and turn the toner save mode off. See the help screen of the printer driver.</li> <li>A combination of faded or smeared defects may indicate that the toner cartridge needs cleaning. (See "Cleaning the inside" on page 47.)</li> </ul>
<p><b>Toner specks</b></p> 	<ul style="list-style-type: none"> <li>The paper may not meet specification; for example, the paper may be too moist or rough. (See "Print media specifications" on page 62.)</li> <li>The transfer roller may be dirty. Clean the inside of your machine. Contact a service representative.</li> <li>The paper path may need cleaning. Contact a service representative.</li> </ul>
<p><b>Dropouts</b></p> 	<p>If faded areas, generally rounded, occur randomly on the page:</p> <ul style="list-style-type: none"> <li>A single sheet of paper may be defective. Try reprinting the job.</li> <li>The moisture content of the paper is uneven or the paper has moist spots on its surface. Try a different brand of paper. (See "Print media specifications" on page 62.)</li> <li>The paper lot is bad. The manufacturing processes can cause some areas to reject toner. Try a different kind or brand of paper.</li> <li>Change the printer option and try again. Go to <b>Printing Preferences</b>, click the <b>Paper</b> tab, and set type to <b>Thick</b>. (See "Opening printing preferences" on page 34.)</li> <li>If these steps do not correct the problem, contact a service representative.</li> </ul>

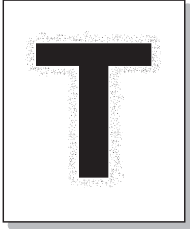
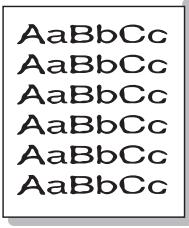
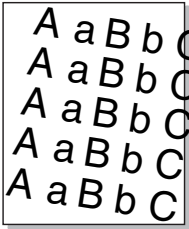
Condition	Suggested Solutions
<p><b>White Spots</b></p> 	<p>If white spots appear on the page:</p> <ul style="list-style-type: none"> <li>The paper is too rough and a lot of dirt from a paper falls to the inner devices within the machine, so the transfer roller may be dirty. Clean the inside of your machine. (See "Cleaning the inside" on page 47.)</li> <li>The paper path may need cleaning. (See "Cleaning the inside" on page 47.)</li> </ul>
<p><b>Vertical lines</b></p> 	<p>If black vertical streaks appear on the page:</p> <ul style="list-style-type: none"> <li>The surface (drum part) of the toner cartridge inside the machine has probably been scratched. Remove the toner cartridge and install a new one. (See "Replacing the toner cartridge" on page 58.)</li> </ul> <p>If white vertical streaks appear on the page:</p> <ul style="list-style-type: none"> <li>The surface of the LSU part inside the machine may be dirty. (See "Cleaning the inside" on page 47.)</li> </ul>
<p><b>Black background</b></p> 	<p>If the amount of background shading becomes unacceptable:</p> <ul style="list-style-type: none"> <li>Change to a lighter weight paper. (See "Print media specifications" on page 62.)</li> <li>Check the environmental conditions: very dry conditions or a high level of humidity (higher than 80% RH) can increase the amount of background shading.</li> <li>Remove the old toner cartridge and, install a new one. (See "Replacing the toner cartridge" on page 58.)</li> </ul>
<p><b>Toner smear</b></p> 	<p>If toner smears on the page:</p> <ul style="list-style-type: none"> <li>Clean the inside of the machine. (See "Cleaning the inside" on page 47.)</li> <li>Check the paper type and quality. (See "Print media specifications" on page 62.)</li> <li>Remove the toner cartridge and then, install a new one. (See "Replacing the toner cartridge" on page 58.)</li> </ul>
<p><b>Vertical repetitive defects</b></p> 	<p>If marks repeatedly appear on the printed side of the page at even intervals:</p> <ul style="list-style-type: none"> <li>The toner cartridge may be damaged. If you still have the same problem, remove the toner cartridge and, install a new one. (See "Replacing the toner cartridge" on page 58.)</li> <li>Parts of the machine may have toner on them. If the defects occur on the back of the page, the problem will likely correct itself after a few more pages.</li> <li>The fusing assembly may be damaged. Contact a service representative.</li> </ul>

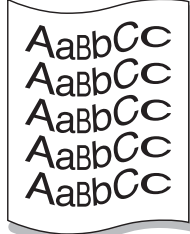
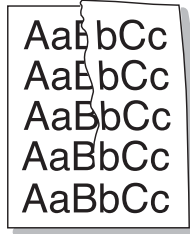
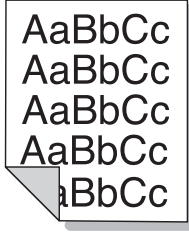
Condition	Suggested Solutions
<b>Background scatter</b> 	<p>Background scatter results from bits of toner randomly distributed on the printed page.</p> <ul style="list-style-type: none"> <li>The paper may be too damp. Try printing with a fresh ream of paper. Do not open packages of paper until necessary so that the paper does not absorb too much moisture.</li> <li>If background scatter occurs on an envelope, change the printing layout to avoid printing over areas that have overlapping seams on the reverse side. Printing on seams can cause problems.</li> <li>If background scatter covers the entire surface area of a printed page, adjust the print quality through your software application or in <b>Printing Preferences</b>. (See "Opening printing preferences" on page 34.)</li> </ul>
<b>Toner particles are around bold characters or pictures</b> 	<p>The toner might not adhere properly to this type of paper.</p> <ul style="list-style-type: none"> <li>Change the printer option and try again. Go to the <b>Printing Preferences</b>, click the <b>Paper</b> tab, and set the paper type to <b>Recycled</b>.</li> </ul>
<b>Misformed characters</b> 	<ul style="list-style-type: none"> <li>If characters are improperly formed and producing hollow images, the paper stock may be too slick. Try different paper. (See "Print media specifications" on page 62.)</li> </ul>
<b>Page skew</b> 	<ul style="list-style-type: none"> <li>Ensure that the paper is loaded properly.</li> <li>Check the paper type and quality. (See "Print media specifications" on page 62.)</li> <li>Ensure that the guides are not too tight or too loose against the paper stack.</li> </ul>

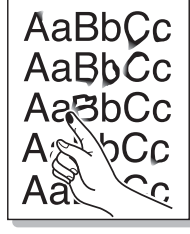
Condition	Suggested Solutions
<b>Curl or wave</b> 	<ul style="list-style-type: none"> <li>Ensure that the paper is loaded properly.</li> <li>Check the paper type and quality. Both high temperature and humidity can cause paper curl. (See "Print media specifications" on page 62.)</li> <li>Turn the stack of paper over in the tray. Also try rotating the paper 180° in the tray.</li> </ul>
<b>Wrinkles or creases</b> 	<ul style="list-style-type: none"> <li>Ensure that the paper is loaded properly.</li> <li>Check the paper type and quality. (See "Print media specifications" on page 62.)</li> <li>Turn the stack of paper over in the tray. Also try rotating the paper 180° in the tray.</li> </ul>
<b>Back of printouts are dirty</b> 	<p>Check for leaking toner. Clean the inside of the machine. (See "Cleaning the inside" on page 47.)</p>
<b>Solid Color or Black pages</b> 	<ul style="list-style-type: none"> <li>The toner cartridge may not be installed properly. Remove the cartridge and reinsert it.</li> <li>The toner cartridge may be defective. Remove the toner cartridge and install a new one. (See "Replacing the toner cartridge" on page 58.)</li> <li>The machine may require repair. Contact a service representative.</li> </ul>
<b>Loose toner</b> 	<ul style="list-style-type: none"> <li>Clean the inside of the machine. (See "Cleaning the inside" on page 47.)</li> <li>Check the paper type and quality. (See "Print media specifications" on page 62.)</li> <li>Remove the toner cartridge and then, install a new one. (See "Replacing the toner cartridge" on page 58.)</li> <li>If the problem persists, the machine may require repair. Contact a service representative.</li> </ul>

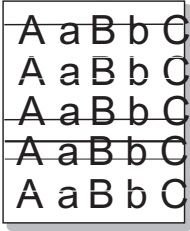
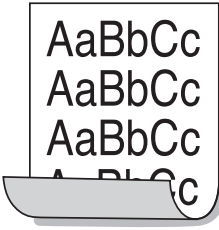
Condition	Suggested Solutions
<b>Character Voids</b> 	<p>Character voids are white areas within parts of characters that should be solid black:</p> <ul style="list-style-type: none"> <li>If you are using transparencies, try another type of transparency. Because of the composition of transparencies, some character voids are normal.</li> <li>You may be printing on the wrong surface of the paper. Remove the paper and turn it over.</li> <li>The paper may not meet paper specifications. (See "Print media specifications" on page 62.)</li> </ul>
<b>Horizontal stripes</b> 	<p>If horizontally aligned black streaks or smears appear:</p> <ul style="list-style-type: none"> <li>The toner cartridge may be installed improperly. Remove the cartridge and reinsert it.</li> <li>The toner cartridge may be defective. Remove the toner cartridge and install a new one. (See "Replacing the toner cartridge" on page 58.)</li> <li>If the problem persists, the machine may require repair. Contact a service representative.</li> </ul>
<b>Curl</b> 	<p>If the printed paper is curled or paper does not feed into the machine:</p> <ul style="list-style-type: none"> <li>Turn the stack of paper over in the tray. Also try rotating the paper 180° in the tray.</li> <li>Change the printer option and try again. Go to <b>Printing Preferences</b>, click <b>Paper</b> tab, and set type to <b>Thin</b>. (See "Opening printing preferences" on page 34.)</li> </ul>

## Common Windows problems

Condition	Suggested solutions
<b>"File in Use" message appears during installation.</b>	<p>Exit all software applications. Remove all software from the startup group, then restart Windows. Reinstall the printer driver.</p>
<b>"General Protection Fault", "Exception OE", "Spool 32", or "Illegal Operation" messages appear.</b>	<p>Close all other applications, reboot Windows and try printing again.</p>
<b>"Fail To Print", "A printer timeout error occurred" messages appear.</b>	<p>These messages may appear during printing. Just keep waiting until the machine finishes printing. If the message appears in ready mode or after printing has been completed, check the connection and/or whether an error has occurred.</p>

 Refer to the Microsoft Windows User's Guide that came with your computer for further information on Windows error messages.

## Common Linux problems

condition	Suggested solutions
<b>The machine does not print.</b>	<ul style="list-style-type: none"> <li>Check if the printer driver is installed in your system. Open the Unified Driver Configurator and switch to the <b>Printers</b> tab in <b>Printers configuration</b> window to look at the list of available machines. Make sure that your machine is displayed on the list. If not, open <b>Add new printer wizard</b> to set up your device.</li> <li>Check if the machine is started. Open <b>Printers configuration</b> and select your machine on the printers list. Look at the description in the <b>Selected printer</b> pane. If its status contains <b>Stopped</b> string, press the <b>Start</b> button. After that normal operation of the machine should be restored. The "stopped" status might be activated when some problems in printing occur.</li> <li>Check if your application is not using a special print option such as "-oraw". If "-oraw" is specified in the command line parameter, then remove it to print properly. For Gimp front-end, select "print" -&gt; "Setup printer" and edit the command line parameter.</li> </ul>
<b>The machine does not print whole pages, and output is printed on half the page.</b>	<p>It is a known problem that occurs when a color machine is used on version 8.51 or earlier of Ghostscript, 64-bit Linux OS, and has been reported to bugs.ghostscript.com as Ghostscript Bug 688252. The problem is solved in AFPL Ghostscript v. 8.52 or above. Download the latest version of AFPL Ghostscript from <a href="http://sourceforge.net/projects/ghostscript/">http://sourceforge.net/projects/ghostscript/</a> and install it to solve this problem.</p>
<b>I encounter the "Cannot open port device file" error when printing a document.</b>	<p>Avoid changing print job parameters (via LPR GUI, for example) while a print job is in progress. Known versions of CUPS server break the print job whenever print options are changed and then try to restart the job from the beginning. Since Unified Linux Driver locks the port while printing, the abrupt termination of the driver keeps the port locked and unavailable for subsequent print jobs. If this situation occurs, try to release the port by selecting <b>Release port</b> in <b>Port configuration</b> window.</p>

 Refer to the Linux User's Guide that came with your computer for further information on Linux error messages.

## Common Macintosh problems

condition	Suggested solutions
<b>The machine does not print PDF files correctly. Some parts of graphics, text, or illustrations are missing.</b>	Printing the PDF file as an image may enable the file to print. Turn on <b>Print As Image</b> from the Acrobat printing options.  It will take longer to print when you print a PDF file as an image.
<b>The document has printed, but the print job has not disappeared from the spooler in Mac OS X 10.3.2.</b>	Update your Mac OS to Mac OS X 10.3.3. or higher.
<b>Some letters are not displayed normally during the Cover page printing.</b>	Mac OS cannot create the font during the Cover page printing. The English alphabet and numbers are displayed normally on the Cover page.
<b>When printing a document in Macintosh with Acrobat Reader 6.0 or higher, colors print incorrectly.</b>	Make sure that the resolution setting in your machine driver matches the one in Acrobat Reader.

 Refer to the Macintosh User's Guide that came with your computer for further information on Macintosh error messages.



This chapter provides information about purchasing supplies and maintenance parts available for your machine.

## This chapter includes:

- How to purchase
- Available supplies

 Available accessories may differ from country to country. Contact your sales representatives to obtain the list of available accessories.

## How to purchase

To order Samsung-authorized supplies, accessories and, maintenance parts, contact your local Samsung dealer or the retailer where you purchased your machine. You can also visit [www.samsung.com/supplies](http://www.samsung.com/supplies), select your country/region, and obtain information on calling for service.

## Available supplies

When supplies reach their lifespan, you can order the following types of supplies for your machine:

### Model Number

- 104 (MLT-D104S): Available in all regions except those listed in Region A and B.
- 1042 (MLT-D1042S): Region A<sup>a</sup>
- 1043 (MLT-D1043S): Region B<sup>b</sup>:
- 104 (MLT-D104X): Not available in all regions.  
\*Refer to your local Samsung website for availability.

a. Region A: Albania, Austria, Belgium, Bosnia, Bulgaria, Croatia, Cyprus, Czech Republic, Denmark, Estonia, Finland, France, Germany, Greece, Hungary, Italy, Latvia, Lithuania, Macedonia, Netherlands, Norway, Poland, Portugal, Romania, Serbia, Slovakia, Slovenia, Spain, Sweden, Switzerland, UK.

b. Region B: China, Bangladesh, India, Nepal, Ukraine, Vietnam.

To replace a toner cartridge see "Replacing the toner cartridge" on page 58.

 Depending on the options and job mode used, the toner cartridge's lifespan may differ.

 You must purchase supplies, including toner cartridges, in the same country where you purchased your machine. Otherwise, supplies will be incompatible with your machine since the system configuration of these vary from country to country.

 Samsung does not recommend using non-genuine Samsung toner cartridge such as refilled or remanufactured. Samsung cannot guarantee non-genuine Samsung toner cartridge's quality. Service or repair required as a result of using non-genuine Samsung toner cartridges will not be covered under the machine warranty.

- Available maintenance parts
- Replacing the toner cartridge

## Available maintenance parts

To avoid print quality and paper feed problems resulting from worn parts and to maintain your machine in top working condition, the following parts will need to be replaced after printing the specified number of pages or when the life span of each item has expired.

Parts	Average yield <sup>a</sup>	Part name
Transfer roller	Approx. 30,000 pages	ROLLER-TRANSFER
Fuser unit	Approx. 30,000 pages	FUSER
Pickup roller	Approx. 30,000 pages	ROLLER-PICK UP

a. Yield is affected by operating system used, computing performance, application software, connecting method, media type, media size and job complexity.

To purchase maintenance parts, contact the source where you bought the machine.

**Replacing maintenance parts can be performed only by an authorized service provider, dealer, or the retailer where you bought the machine. The warranty does not cover the replacement of any maintenance parts once they have reached their "Average yield".**

## Replacing the toner cartridge

 Click this link to open an animation about replacing a toner cartridge.

When the toner cartridge reaches its estimated cartridge life,

- The Printer Status or the Smart Panel program window appears on the computer telling you the toner cartridge needs to be replaced.
- The machine stops printing.

At this stage, the toner cartridge needs to be replaced. Check the model number for the toner cartridge used in your machine. (See "Available supplies" on page 58.)

1. Open the top cover.

 When you open the top cover, make sure that the output tray is closed.

2. Pull the toner cartridge out.

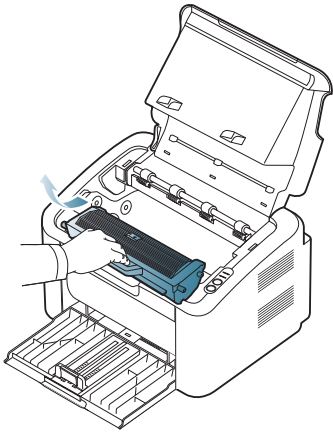

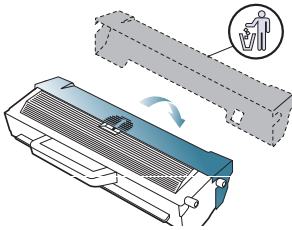

3. Take a new toner cartridge out of its package.  
4. Remove the cap protecting the toner cartridge.

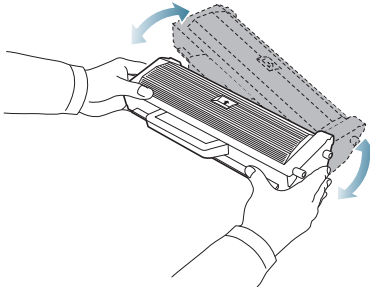

5. Slowly shake the cartridge side to side five or six times to distribute the toner evenly inside the cartridge. It will assure maximum copies per cartridge.



 If toner gets on your clothing, wipe it off with a dry cloth and wash clothing in cold water. Hot water sets toner into fabric.

 Do not touch the drum located in the toner cartridge or imaging unit. Use the handle on the cartridge to avoid touching this area.

6. Hold the toner cartridge by the handle and slowly insert the cartridge into the opening in the machine.

Tabs on the sides of the cartridge and corresponding grooves within the machine will guide the cartridge into the correct position until it locks into

place completely.

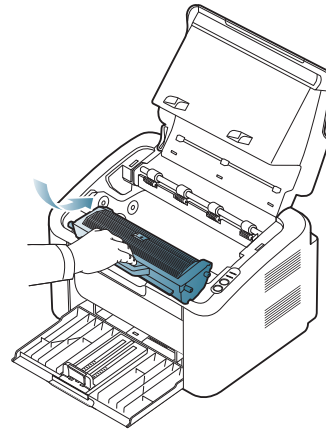

7. Close the top cover. Make sure that the cover is securely closed.

# specifications

This chapter covers the machines primary specifications.

**This chapter includes:**

- Hardware specifications
- Environmental specifications
- Electrical specifications
- Print media specifications

 The specification values are listed below: specifications are subject to change without notice: See [www.samsung.com/printer](http://www.samsung.com/printer) for possible changes in information.

## Hardware specifications

Item		Description
Dimension	Height	184 mm (7.24 inches)
	Depth	224 mm (8.82 inches)
	Width	341 mm (13.43 inches)
Weight	without Imaging Cartridge	4.2 kg (9.26 lbs)

## Environmental specifications

Item		Description
Noise Level <sup>a</sup>	Ready mode	26 dB(A)
	Printing mode	50 dB(A)
Temperature	Operation	10 to 32 °C (50 to 90 °F)
	Storage (unpacked)	0 to 40 °C (32 to 104 °F)
Humidity	Operation	10 to 80% RH
	Storage (unpacked)	20 to 80% RH

a. Sound Pressure Level, ISO 7779. Configuration tested: machine basic installation, A4 paper, simplex printing.

## Electrical specifications

 Power requirements are based on the country/region where the device is sold. Do not convert operating voltages. Doing so might damage the device and void the product warranty.

Item		Description
Power rating <sup>a</sup>	110 volt models	AC 110 - 127 V
	220 volt models	AC 220 - 240 V



	Item	Description
<b>Power consumption</b>	Average operating mode	Less than 270 W
	Ready mode	Less than 40 W
	Power save mode	Less than 2.8 W
	Power off mode	Less than 0.45 W

a. See the rating label on the machine for the correct voltage(V), frequency (hertz) and type of current (A) for your machine.

## Print media specifications

Type	Size	Dimensions	Print media weight <sup>a</sup> /Capacity <sup>b</sup>	
			Tray	Manual feeding in the tray
<b>Plain paper</b>	Letter	216 x 279 mm (8.50 x 11.00 inches)	60 to 120 g/m <sup>2</sup> (16 to 32 lbs bond) • 150 sheets of 80 g/m <sup>2</sup> (20 lbs bond)	60 to 163 g/m <sup>2</sup> (16 to 43 lbs bond) • 1 sheet for manual feeding in the tray
	Legal	216 x 356 mm (8.50 x 14.00 inches)		
	US Folio	216 x 330 mm (8.50 x 13.00 inches)		
	A4	210 x 297 mm (8.27 x 11.69 inches)		
	Oficio	216 x 343 mm (8.50 x 13.50 inches)		
	JIS B5	182 x 257 mm (7.17 x 10.12 inches)		
	ISO B5	176 x 250 mm (6.93 x 9.84 inches)		
	Executive	184 x 267 mm (7.25 x 0 inches)		
	A5	148 x 210 mm (5.83 x 8.27 inches)		
<b>Envelope</b>	Envelope Monarch	98 x 191 mm (3.87 x 7.50 inches)	75 to 90 g/m <sup>2</sup> (20 to 24 lbs bond) • 1 sheet for manual feeding in the tray	
	Envelope No. 10	105 x 241 mm (4.12 x 9.50 inches)		
	Envelope DL	110 x 220 mm (4.33 x 8.66 inches)		
	Envelope C5	162 x 229 mm (6.38 x 9.02 inches)		
<b>Thick paper</b>	Refer to the Plain paper section	Refer to the Plain paper section	90 g/m <sup>2</sup> (24 lbs bond) • 140 sheets	90 to 163 g/m <sup>2</sup> (24 to 43 lbs bond) • 1 sheet for manual feeding in the tray
<b>Thin paper</b>	Refer to the Plain paper section	Refer to the Plain paper section	60 to 70 g/m <sup>2</sup> (16 to 19 lbs bond) • 1 sheet for manual feeding in the tray	
<b>Transparency</b>	Letter, A4	Refer to the Plain paper section	138 to 146 g/m <sup>2</sup> (37 to 39 lbs bond) • 1 sheet for manual feeding in the tray	
<b>Labels<sup>c</sup></b>	Letter, Legal, US Folio, A4, JIS B5, ISO B5, Executive, A5	Refer to the Plain paper section	120 to 150 g/m <sup>2</sup> (32 to 40 lbs bond) • 1 sheet for manual feeding in the tray	
<b>Card stock</b>	Letter, Legal, US Folio, A4, JIS B5, ISO B5, Executive, A5	Refer to the Plain paper section	105 to 163 g/m <sup>2</sup> (28 to 43 lbs bond) • 1 sheet for manual feeding in the tray	
<b>Minimum size (custom)</b>		76 x 183 mm (3.00 x 7.20 inches)	60 to 163 g/m <sup>2</sup> (16 to 43 lbs bond)	
<b>Maximum size (custom)</b>		216 x 356 mm (8.50 x 14.02 inches)		

a. If media weight is over 120 g/m<sup>2</sup> (32 lbs), load a paper into the tray one by one.

b. Maximum capacity may differ depending on media weight, thickness and environmental conditions.

c. Smoothness: 100 to 250 (sheffield).

# contact samsung worldwide

If you have any comments or questions regarding Samsung products, contact the Samsung customer care center.

Country/Region	Customer Care Center	Web Site
<b>ARGENTINE</b>	0800-333-3733	www.samsung.com
<b>ARMENIA</b>	0-800-05-555	
<b>AUSTRALIA</b>	1300 362 603	www.samsung.com
<b>AUSTRIA</b>	0810-SAMSUNG (7267864, € 0.07/min)	www.samsung.com
<b>AZERBAIJAN</b>	088-55-55-555	
<b>BAHRAIN</b>	8000-4726	
<b>BELARUS</b>	810-800-500-55-500	www.samsung.ua www.samsung.com/ua_ru
<b>BELGIUM</b>	02-201-24-18	www.samsung.com/be (Dutch) www.samsung.com/be_fr (French)
<b>BRAZIL</b>	0800-124-421 4004-0000	www.samsung.com
<b>CANADA</b>	1-800-SAMSUNG (726-7864)	www.samsung.com
<b>CHILE</b>	800-SAMSUNG (726-7864)	www.samsung.com
<b>CHINA</b>	400-810-5858 010-6475 1880	www.samsung.com
<b>COLOMBIA</b>	01-8000112112	www.samsung.com
<b>COSTA RICA</b>	0-800-507-7267	www.samsung.com
<b>CZECH REPUBLIC</b>	800-SAMSUNG (800-726786) Samsung Zrt., česká organizační složka, Oasis Florenc, Sokolovská394/17, 180 00, Praha 8	www.samsung.com
<b>DENMARK</b>	70 70 19 70	www.samsung.com
<b>ECUADOR</b>	1-800-10-7267	www.samsung.com
<b>EGYPT</b>	0800-726786	
<b>EIRE</b>	0818 717100	www.samsung.com
<b>EL SALVADOR</b>	800-6225	www.samsung.com
<b>ESTONIA</b>	800-7267	www.samsung.com
<b>KAZAKHSTAN</b>	8-10-800-500-55-500	www.samsung.com/kz_ru
<b>KYRGYZSTAN</b>	00-800-500-55-500	
<b>FINLAND</b>	030-6227 515	www.samsung.com
<b>FRANCE</b>	01 48 63 00 00	www.samsung.com

Country/Region	Customer Care Center	Web Site
<b>GERMANY</b>	01805 - SAMSUNG (726-7864 € 0,14/min)	www.samsung.com
<b>GEORGIA</b>	8-800-555-555	
<b>GUATEMALA</b>	1-800-299-0013	www.samsung.com
<b>HONDURAS</b>	800-7919267	www.samsung.com
<b>HONG KONG</b>	(852) 3698-4698	www.samsung.com/hk www.samsung.com/hk_en/
<b>HUNGARY</b>	06-80-SAMSUNG (726-7864)	www.samsung.com
<b>INDIA</b>	3030 8282 1800 110011 1800 3000 8282 1800 266 8282	www.samsung.com
<b>INDONESIA</b>	0800-112-8888 021-5699-7777	www.samsung.com
<b>ITALIA</b>	800-SAMSUNG (726-7864)	www.samsung.com
<b>JAMAICA</b>	1-800-234-7267	www.samsung.com
<b>JAPAN</b>	0120-327-527	www.samsung.com
<b>JORDAN</b>	800-22273	
<b>KSA</b>	9200-21230	www.samsung.com
<b>LATVIA</b>	8000-7267	www.samsung.com
<b>LITHUANIA</b>	8-800-77777	www.samsung.com
<b>LUXEMBURG</b>	261 03 710	www.samsung.com
<b>MALAYSIA</b>	1800-88-9999	www.samsung.com
<b>MEXICO</b>	01-800-SAMSUNG (726-7864)	www.samsung.com
<b>MOLDOVA</b>	00-800-500-55-500	www.samsung.ua www.samsung.com/ua_ru
<b>NETHERLANDS</b>	0900-SAMSUNG (0900-7267864) (€ 0,10/min)	www.samsung.com
<b>NEW ZEALAND</b>	0800 SAMSUNG (0800 726 786)	www.samsung.com
<b>NICARAGUA</b>	00-1800-5077267	www.samsung.com
<b>NORWAY</b>	815-56 480	www.samsung.com
<b>PANAMA</b>	800-7267	www.samsung.com

Country/Region	Customer Care Center	Web Site
<b>PHILIPPINES</b>	1800-10-SAMSUNG (726-7864) 1-800-3-SAMSUNG (726-7864) 1-800-8-SAMSUNG (726-7864) 02-5805777	www.samsung.com
<b>POLAND</b>	0 801 1SAMSUNG (172678) 022-607-93-33	www.samsung.com
<b>PORTUGAL</b>	80820-SAMSUNG (726-7864)	www.samsung.com
<b>PUERTO RICO</b>	1-800-682-3180	www.samsung.com
<b>QATAR</b>	800-2255	
<b>REP. DOMINICA</b>	1-800-751-2676	www.samsung.com
<b>RUSSIA</b>	8-800-555-55-55	www.samsung.ru
<b>SINGAPORE</b>	1800-SAMSUNG (726-7864)	www.samsung.com
<b>SLOVAKIA</b>	0800-SAMSUNG (726-7864)	www.samsung.com
<b>SOUTH AFRICA</b>	0860 SAMSUNG (726-7864)	www.samsung.com
<b>SPAIN</b>	902-1-SAMSUNG(902 172 678)	www.samsung.com
<b>SWEDEN</b>	0771 726 7864 (SAMSUNG)	www.samsung.com
<b>SWITZERLAND</b>	0848-SAMSUNG (7267864, CHF 0.08/min)	www.samsung.com
<b>SYRIA</b>	1825-22-73	
<b>TADJIKISTAN</b>	8-10-800-500-55-500	
<b>TAIWAN</b>	0800-329-999	www.samsung.com
<b>THAILAND</b>	1800-29-3232 02-689-3232	www.samsung.com
<b>TRINIDAD &amp; TOBAGO</b>	1-800-SAMSUNG (726-7864)	www.samsung.com
<b>TURKEY</b>	444 77 11	www.samsung.com
<b>U.A.E</b>	800-SAMSUNG (726-7864)	www.samsung.com
<b>U.K</b>	0845 SAMSUNG (726-7864)	www.samsung.com
<b>U.S.A</b>	1-800-SAMSUNG (726-7864)	www.samsung.com
<b>UKRAINE</b>	8-800-502-000	www.samsung.ua www.samsung.com/ua_ru

Country/Region	Customer Care Center	Web Site
<b>UZBEKISTAN</b>	8-10-800-500-55-500	www.samsung.com/kz_ru
<b>VENEZUELA</b>	0-800-100-5303	www.samsung.com
<b>VIETNAM</b>	1 800 588 889	www.samsung.com

 The following glossary helps you get familiar with the product by understanding the terminologies commonly used with printing as well as mentioned in this user's guide.

## 802.11

802.11 is a set of standards for wireless local area network (WLAN) communication, developed by the IEEE LAN/MAN Standards Committee (IEEE 802).

## 802.11b/g/n

802.11b/g/n can share same hardware and use the 2.4 GHz band. 802.11b supports bandwidth up to 11 Mbps, 802.11n supports bandwidth up to 150 Mbps. 802.11b/g/n devices may occasionally suffer interference from microwave ovens, cordless telephones, and Bluetooth devices.

## Access point

Access Point or Wireless Access Point (AP or WAP) is a device that connects wireless communication devices together on wireless local area networks (WLAN), and acts as a central transmitter and receiver of WLAN radio signals.

## ADF

An Automatic Document Feeder (ADF) is a scanning unit that will automatically feed an original sheet of paper so that the machine can scan some amount of the paper at once.

## AppleTalk

AppleTalk is a proprietary suite of protocols developed by Apple, Inc for computer networking. It was included in the original Macintosh (1984) and is now deprecated by Apple in favor of TCP/IP networking.

## BIT Depth

A computer graphics term describing the number of bits used to represent the color of a single pixel in a bitmapped image. Higher color depth gives a broader range of distinct colors. As the number of bits increases, the number of possible colors becomes impractically large for a color map. 1-bit color is commonly called as monochrome or black and white.

## BMP

A bitmapped graphics format used internally by the Microsoft Windows graphics subsystem (GDI), and used commonly as a simple graphics file format on that platform.

## BOOTP

Bootstrap Protocol. A network protocol used by a network client to obtain its IP address automatically. This is usually done in the bootstrap process of computers or operating systems running on them. The BOOTP servers assign the IP address from a pool of addresses to each

client. BOOTP enables 'diskless workstation' computers to obtain an IP address prior to loading any advanced operating system.

## CCD

Charge Coupled Device (CCD) is a hardware which enables the scan job. CCD Locking mechanism is also used to hold the CCD module to prevent any damage when you move the machine.

## Collation

Collation is a process of printing a multiple-copy job in sets. When collation is selected, the device prints an entire set before printing additional copies.

## Control Panel

A control panel is a flat, typically vertical, area where control or monitoring instruments are displayed. They are typically found in front of the machine.

## Coverage

It is the printing term used for a toner usage measurement on printing. For example, 5% coverage means that an A4 sided paper has about 5% image or text on it. So, if the paper or original has complicated images or lots of text on it, the coverage will be higher and at the same time, a toner usage will be as much as the coverage.

## CSV

Comma Separated Values (CSV). A type of file format, CSV is used to exchange data between disparate applications. The file format, as it is used in Microsoft Excel, has become a de facto standard throughout the industry, even among non-Microsoft platforms.

## DADF

A Duplex Automatic Document Feeder (DADF) is a scanning unit that will automatically feed and turn over an original sheet of paper so that the machine can scan on both sides of the paper.

## Default

The value or setting that is in effect when taking a printer out of its box state, reset, or initialized.

## DHCP

A Dynamic Host Configuration Protocol (DHCP) is a client-server networking protocol. A DHCP server provides configuration parameters specific to the DHCP client host requesting, generally, information required by the client host to participate on an IP network. DHCP also provides a mechanism for allocation of IP addresses to client hosts.

## **DIMM**

Dual Inline Memory Module (DIMM), a small circuit board that holds memory. DIMM stores all the data within the machine like printing data, received fax data.

## **DLNA**

The Digital Living Network Alliance (DLNA) is a standard that allows devices on a home network to share information with each other across the network.

## **DMPr**

The Digital Media Printer (DMPr) is a device that allows printing in DLNA home network. The DMPr prints a page by combining images with an Extensible HyperText Markup Language (XHTML) template.

## **DNS**

The Domain Name Server (DNS) is a system that stores information associated with domain names in a distributed database on networks, such as the Internet.

## **Dot Matrix Printer**

A dot matrix printer refers to a type of computer printer with a print head that runs back and forth on the page and prints by impact, striking an ink-soaked cloth ribbon against the paper, much like a typewriter.

## **DPI**

Dots Per Inch (DPI) is a measurement of resolution that is used for scanning and printing. Generally, higher DPI results in a higher resolution, more visible detail in the image, and a larger file size.

## **DRPD**

Distinctive Ring Pattern Detection. Distinctive Ring is a telephone company service which enables a user to use a single telephone line to answer several different telephone numbers.

## **Duplex**

A mechanism that will automatically turn over a sheet of paper so that the machine can print (or scan) on both sides of the paper. A printer equipped with a Duplex Unit can print on both sides of paper during one print cycle.

## **Duty Cycle**

Duty cycle is the page quantity which does not affect printer performance for a month. Generally the printer has the lifespan limitation such as pages per year. The lifespan means the average capacity of print-outs, usually within the warranty period. For example, if the duty cycle is 48,000 pages per month assuming 20 working days, a printer limits 2,400 pages a day.

## **ECM**

Error Correction Mode (ECM) is an optional transmission mode built into Class 1 fax machines or fax modems. It automatically detects and corrects errors in the fax transmission process that are sometimes caused by telephone line noise.

## **Emulation**

Emulation is a technique of one machine obtaining the same results as another.

An emulator duplicates the functions of one system with a different system, so that the second system behaves like the first system. Emulation focuses on exact reproduction of external behavior, which is in contrast to simulation, which concerns an abstract model of the system being simulated, often considering its internal state.

## **Ethernet**

Ethernet is a frame-based computer networking technology for local area networks (LANs). It defines wiring and signaling for the physical layer, and frame formats and protocols for the media access control (MAC)/data link layer of the OSI model. Ethernet is mostly standardized as IEEE 802.3. It has become the most widespread LAN technology in use during the 1990s to the present.

## **EtherTalk**

A suite of protocols developed by Apple Computer for computer networking. It was included in the original Macintosh (1984) and is now deprecated by Apple in favor of TCP/IP networking.

## **FDI**

Foreign Device Interface (FDI) is a card installed inside the machine to allow a third party device such as a coin operated device or a card reader. Those devices allow the pay-for-print service on your machine.

## **FTP**

A File Transfer Protocol (FTP) is a commonly used protocol for exchanging files over any network that supports the TCP/IP protocol (such as the Internet or an intranet).

## **Fuser Unit**

The part of a laser printer that fuses the toner onto the print media. It consists of a heat roller and a pressure roller. After toner is transferred onto the paper, the fuser unit applies heat and pressure to ensure that the toner stays on the paper permanently, which is why paper is warm when it comes out of a laser printer.

## **Gateway**

A connection between computer networks, or between a computer network and a telephone line. It is very popular, as it is a computer or a network that allows access to another computer or network.

## **Grayscale**

A shades of gray that represent light and dark portions of an image when color images are converted to grayscale; colors are represented by various shades of gray.

## **Halftone**

An image type that simulates grayscale by varying the number of dots. Highly colored areas consist of a large number of dots, while lighter areas consist of a smaller number of dots.

## **HDD**

Hard Disk Drive (HDD), commonly referred to as a hard drive or hard disk, is a non-volatile storage device which stores digitally-encoded data on rapidly rotating platters with magnetic surfaces.

## **IEEE**

The Institute of Electrical and Electronics Engineers (IEEE) is an international non-profit, professional organization for the advancement of technology related to electricity.

## **IEEE 1284**

The 1284 parallel port standard was developed by the Institute of Electrical and Electronics Engineers (IEEE). The term "1284-B" refers to a specific connector type on the end of the parallel cable that attaches to the peripheral (for example, a printer).

## **Intranet**

A private network that uses Internet Protocols, network connectivity, and possibly the public telecommunication system to securely share part of an organization's information or operations with its employees.

Sometimes the term refers only to the most visible service, the internal website.

## **IP address**

An Internet Protocol (IP) address is a unique number that devices use in order to identify and communicate with each other on a network utilizing the Internet Protocol standard.

## **IPM**

The Images Per Minute (IPM) is a way of measuring the speed of a printer. An IPM rate indicates the number of single-sided sheets a printer can complete within one minute.

## **IPP**

The Internet Printing Protocol (IPP) defines a standard protocol for printing as well as managing print jobs, media size, resolution, and so forth. IPP can be used locally or over the Internet to hundreds of printers, and also supports access control, authentication, and encryption, making it a much more capable and secure printing solution than older ones.

## **IPX/SPX**

IPX/SPX stands for Internet Packet Exchange/Sequenced Packet Exchange. It is a networking protocol used by the Novell NetWare operating systems. IPX and SPX both provide connection services similar to TCP/IP, with the IPX protocol having similarities to IP, and SPX having similarities to TCP. IPX/SPX was primarily designed for local area networks (LANs), and is a very efficient protocol for this purpose (typically its performance exceeds that of TCP/IP on a LAN).

## **ISO**

The International Organization for Standardization (ISO) is an international standard-setting body composed of representatives from national standards bodies. It produces world-wide industrial and commercial standards.

## **ITU-T**

The International Telecommunication Union is an international organization established to standardize and regulate international radio and telecommunications. Its main tasks include standardization, allocation of the radio spectrum, and organizing interconnection arrangements between different countries to allow international phone calls. A -T out of ITU-T indicates telecommunication.

## **ITU-T No. 1 chart**

Standardized test chart published by ITU-T for document facsimile transmissions.

## **JBIG**

Joint Bi-level Image Experts Group (JBIG) is an image compression standard with no loss of accuracy or quality, which was designed for compression of binary images, particularly for faxes, but can also be used on other images.

## **JPEG**

Joint Photographic Experts Group (JPEG) is a most commonly used standard method of lossy compression for photographic images. It is the format used for storing and transmitting photographs on the World Wide Web.

## **LDAP**

The Lightweight Directory Access Protocol (LDAP) is a networking protocol for querying and modifying directory services running over TCP/IP.

## **LED**

A Light-Emitting Diode (LED) is a semiconductor device that indicates the status of a machine.

## **MAC address**

Media Access Control (MAC) address is a unique identifier associated with a network adapter. MAC address is a unique 48-bit identifier usually written as 12 hexadecimal characters grouped in pairs (e. g., 00-00-0c-34-11-4e). This address is usually hard-coded into a Network Interface Card (NIC) by its manufacturer, and used as an aid for routers trying to locate machines on large networks.

## **MFP**

Multi Function Peripheral (MFP) is an office machine that includes the following functionality in one physical body, so as to have a printer, a copier, a fax, a scanner and etc.

## **MH**

Modified Huffman (MH) is a compression method for decreasing the amount of data that needs to be transmitted between the fax machines to transfer the image recommended by ITU-T T.4. MH is a codebook-based run-length encoding scheme optimized to efficiently compress white space. As most faxes consist mostly of white space, this minimizes the transmission time of most faxes.



## **MMR**

Modified Modified READ (MMR) is a compression method recommended by ITU-T T.6.

## **Modem**

A device that modulates a carrier signal to encode digital information, and also demodulates such a carrier signal to decode transmitted information.

## **MR**

Modified Read (MR) is a compression method recommended by ITU-T T.4. MR encodes the first scanned line using MH. The next line is compared to the first, the differences determined, and then the differences are encoded and transmitted.

## **NetWare**

A network operating system developed by Novell, Inc. It initially used cooperative multitasking to run various services on a PC, and the network protocols were based on the archetypal Xerox XNS stack. Today NetWare supports TCP/IP as well as IPX/SPX.

## **OPC**

Organic Photo Conductor (OPC) is a mechanism that makes a virtual image for print using a laser beam emitted from a laser printer, and it is usually green or rust colored and has a cylinder shape.

An imaging unit containing a drum slowly wears the drum surface by its usage in the printer, and it should be replaced appropriately since it gets worn from contact with the cartridge development brush, cleaning mechanism, and paper.

## **Originals**

The first example of something, such as a document, photograph or text, etc, which is copied, reproduced or translated to produce others, but which is not itself copied or derived from something else.

## **OSI**

Open Systems Interconnection (OSI) is a model developed by the International Organization for Standardization (ISO) for communications. OSI offers a standard, modular approach to network design that divides the required set of complex functions into manageable, self-contained, functional layers. The layers are, from top to bottom, Application, Presentation, Session, Transport, Network, Data Link and Physical.

## **PABX**

A private automatic branch exchange (PABX) is an automatic telephone switching system within a private enterprise.

## **PCL**

Printer Command Language (PCL) is a Page Description Language (PDL) developed by HP as a printer protocol and has become an industry standard. Originally developed for early inkjet printers, PCL has been released in varying levels for thermal, dot matrix printer, and laser printers.

## **PDF**

Portable Document Format (PDF) is a proprietary file format developed by Adobe Systems for representing two dimensional documents in a device independent and resolution independent format.

## **PostScript**

PostScript (PS) is a page description language and programming language used primarily in the electronic and desktop publishing areas. - that is run in an interpreter to generate an image.

## **Printer Driver**

A program used to send commands and transfer data from the computer to the printer.

## **Print Media**

The media like paper, envelopes, labels, and transparencies which can be used in a printer, a scanner, a fax or, a copier.

## **PPM**

Pages Per Minute (PPM) is a method of measurement for determining how fast a printer works, meaning the number of pages a printer can produce in one minute.

## **PRN file**

An interface for a device driver, this allows software to interact with the device driver using standard input/output system calls, which simplifies many tasks.

## **Protocol**

A convention or standard that controls or enables the connection, communication, and data transfer between two computing endpoints.

## **PS**

See PostScript.

## **PSTN**

The Public-Switched Telephone Network (PSTN) is the network of the world's public circuit-switched telephone networks which, on industrial premises, is usually routed through the switchboard.

## **RADIUS**

Remote Authentication Dial In User Service (RADIUS) is a protocol for remote user authentication and accounting. RADIUS enables centralized management of authentication data such as usernames and passwords using an AAA (authentication, authorization, and accounting) concept to manage network access.

## **Resolution**

The sharpness of an image, measured in Dots Per Inch (DPI). The higher the dpi, the greater the resolution.

## **SMB**

Server Message Block (SMB) is a network protocol mainly applied to share files, printers, serial ports, and miscellaneous communications

between nodes on a network. It also provides an authenticated Inter-process communication mechanism.

## **SMTP**

Simple Mail Transfer Protocol (SMTP) is the standard for e-mail transmissions across the Internet. SMTP is a relatively simple, text-based protocol, where one or more recipients of a message are specified, and then the message text is transferred. It is a client-server protocol, where the client transmits an email message to the server.

## **SSID**

Service Set Identifier (SSID) is a name of a wireless local area network (WLAN). All wireless devices in a WLAN use the same SSID in order to communicate with each other. The SSIDs are case-sensitive and have a maximum length of 32 characters.

## **Subnet Mask**

The subnet mask is used in conjunction with the network address to determine which part of the address is the network address and which part is the host address.

## **TCP/IP**

The Transmission Control Protocol (TCP) and the Internet Protocol (IP); the set of communications protocols that implement the protocol stack on which the Internet and most commercial networks run.

## **TCR**

Transmission Confirmation Report (TCR) provides details of each transmission such as job status, transmission result and number of pages sent. This report can be set to print after each job or only after failed transmissions.

## **TIFF**

Tagged Image File Format (TIFF) is a variable-resolution bitmapped image format. TIFF describes image data that typically come from scanners. TIFF images make use of tags, keywords defining the characteristics of the image that is included in the file. This flexible and platform-independent format can be used for pictures that have been made by various image processing applications.

## **Toner Cartridge**

A kind of bottle or container used in a machine like a printer which contains toner. Toner is a powder used in laser printers and photocopiers, which forms the text and images on the printed paper. Toner can be fused by a combination of heat/pressure from the fuser, causing it to bind to the fibers in the paper.

## **TWAIN**

An industry standard for scanners and software. By using a TWAIN-compliant scanner with a TWAIN-compliant program, a scan can be initiated from within the program. It is an image capture API for Microsoft Windows and Apple Macintosh operating systems.

## **UNC Path**

Uniform Naming Convention (UNC) is a standard way to access network shares in Window NT and other Microsoft products. The format of a UNC path is: \\<servername>\<sharename>\<Additional directory>

## **URL**

Uniform Resource Locator (URL) is the global address of documents and resources on the Internet. The first part of the address indicates what protocol to use, the second part specifies the IP address or the domain name where the resource is located.

## **USB**

Universal Serial Bus (USB) is a standard that was developed by the USB Implementers Forum, Inc., to connect computers and peripherals. Unlike the parallel port, USB is designed to concurrently connect a single computer USB port to multiple peripherals.

## **Watermark**

A watermark is a recognizable image or pattern in paper that appears lighter when viewed by transmitted light. Watermarks were first introduced in Bologna, Italy in 1282; they have been used by papermakers to identify their product, and also on postage stamps, currency, and other government documents to discourage counterfeiting.

## **WEP**

Wired Equivalent Privacy (WEP) is a security protocol specified in IEEE 802.11 to provide the same level of security as that of a wired LAN. WEP provides security by encrypting data over radio so that it is protected as it is transmitted from one end point to another.

## **WIA**

Windows Imaging Architecture (WIA) is an imaging architecture that is originally introduced in Windows Me and Windows XP. A scan can be initiated from within these operating systems by using a WIA-compliant scanner.

## **WPA**

Wi-Fi Protected Access (WPA) is a class of systems to secure wireless (Wi-Fi) computer networks, which was created to improve upon the security features of WEP.

## **WPA-PSK**

WPA-PSK (WPA Pre-Shared Key) is special mode of WPA for small business or home users. A shared key, or password, is configured in the wireless access point (WAP) and any wireless laptop or desktop devices. WPA-PSK generates a unique key for each session between a wireless client and the associated WAP for more advanced security.

## **WPS**

The Wi-Fi Protected Setup (WPS) is a standard for establishing a wireless home network. If your wireless access point supports WPS, you can configure the wireless network connection easily without a computer.

**XPS**

XML Paper Specification (XPS) is a specification for a Page Description Language (PDL) and a new document format, which has benefits for portable document and electronic document, developed by Microsoft. It is an XML-based specification, based on a new print path and a vector-based device-independent document format.